



SERVICE MANUAL

VHF AIR BAND TRANSCEIVER

IC-A22

IC-A22E

IC-A3

IC-A3E

INTRODUCTION

This service manual describes the latest service information for the **IC-A22/E** and **IC-A3/E** VHF AIR BAND TRANSCEIVER at the time of publication.

5 versions of the **IC-A22/E** and 5 versions of the **IC-A3/E** have been designed. This service manual covers each version.

MODEL	VERSION NO.	VERSION	SYMBOL
IC-A22	#01	U.S.A.	USA
IC-A22E	#03	Europe	EUR
	#04	Europe	EUR-1
	#05	Australia	AUS
	#06	U.K.	UK
IC-A3	#01	U.S.A.	USA
IC-A3E	#03	Europe	EUR
	#04	Europe	EUR-1
	#05	Australia	AUS
	#06	U.K.	UK

To upgrade quality, any electrical or mechanical parts and internal circuits are subject to change without notice or obligation.

DANGER

NEVER connect the transceiver to an AC outlet or to a DC power supply that uses more than 15 V. This will ruin the transceiver.

DO NOT expose the transceiver to rain, snow or any liquids.

DO NOT reverse the polarities of the power supply when connecting the transceiver.

DO NOT apply an RF signal of more than 20 dBm (100 mW) to the antenna connector. This could damage the transceiver's front end.

ORDERING PARTS

Be sure to include the following four points when ordering replacement parts:

1. 10-digit order numbers
2. Component part number and name
3. Equipment model name and unit name
4. Quantity required

<SAMPLE ORDER>

1110003680 IC SC1303 IC-A22 RF UNIT 5 pieces
8810008480 Screw PH BT M2X29 ZK IC-A22 Rear Panel 10 pieces

Address are provided on the inside back cover for your convenience.



REPAIR NOTES

1. Make sure a problem is internal before disassembling the transceiver.
2. **DO NOT** open the transceiver until the transceiver is disconnected from its power source.
3. **DO NOT** force any of the variable components. Turn them slowly and smoothly.
4. **DO NOT** short any circuits or electronic parts. An insulated tuning tool **MUST** be used for all adjustments.
5. **DO NOT** keep power ON for a long time when the transceiver is defective.
6. **DO NOT** transmit power into a signal generator or a sweep generator.
7. **ALWAYS** connect a 40 dB to 50 dB attenuator between the transceiver and a deviation meter or spectrum analyzer when using such test equipment.
8. **READ** the instructions of test equipment thoroughly before connecting equipment to the transceiver.

TABLE OF CONTENTS

SECTION	1	SPECIFICATIONS	1 - 1
SECTION	2	INSIDE VIEWS	2 - 1
SECTION	3	CIRCUIT DESCRIPTION	3 - 1 to 3 - 4
	3 - 1	RECEIVER CIRCUITS	3 - 1
	3 - 2	TRANSMITTER CIRCUITS	3 - 3
	3 - 3	PLL CIRCUITS	3 - 3
	3 - 4	POWER SUPPLY CIRCUITS	3 - 4
	3 - 5	CPU PORT ALLOCATIONS	3 - 4
SECTION	4	ADJUSTMENT PROCEDURES	4 - 1 to 4 - 4
	4 - 1	PLL AND TRANSMITTER ADJUSTMENTS	4 - 1
	4 - 2	RECEIVER ADJUSTMENT	4 - 3
SECTION	5	PARTS LIST	5 - 1 to 5 - 6
SECTION	6	MECHANICAL PARTS AND DISASSEMBLY	6 - 1 to 6 - 2
SECTION	7	BLOCK DIAGRAM	7 - 1
SECTION	8	SEMI-CONDUCTOR INFORMATION	8 - 1
SECTION	9	BOARD LAYOUTS	9 - 1 to 9 - 9
	9 - 1	PTT UNIT, VCO BOARD AND PRT UNIT	9 - 1
	9 - 2	RF UNIT	9 - 2
	9 - 3	MAIN UNIT	9 - 4
	9 - 4	LOGIC UNIT	9 - 6
SECTION	10	VOLTAGE DIAGRAM	10 - 1 to 10 - 2

SECTION 1 SPECIFICATIONS

■ GENERAL

- Frequency coverage (MHz) :

		IC-A22	IC-A22E	IC-A3	IC-A3E
Tx	Communications	118.000-136.975	118.000-136.975	118.000-136.975	118.000-136.975
	Communications	118.000-136.975	118.000-136.975	118.000-136.975	118.000-136.975
Rx	Navigation	108.000-117.975	108.000-117.975	—	—
	Weather	161.650-163.275	—	161.650-163.275	—
- Mode : Tx/Rx AM (6K00A3E)
Rx FM (16K0G3E; for weather channel) U.S.A. version only
- Number of memory channels : 50
- Channel spacing : 25 kHz
- Frequency stability : $\pm 0.002\%$ (-10°C to $+50^{\circ}\text{C}$; $+14^{\circ}\text{F}$ to $+122^{\circ}\text{F}$)
- Antenna impedance : $50\ \Omega$ (nominal)
- Power supply requirement : 12–15 V DC (negative ground)
- Usable temperature range : -10°C to $+50^{\circ}\text{C}$; $+14^{\circ}\text{F}$ to $+122^{\circ}\text{F}$
- Current drain (at 12 V DC) :

	IC-A22/E	IC-A3/E
Transmit	1.0 A typical	1.0 A typical
Rated audio	400 mA max.	240 mA typical
Squelched	55 mA typical	55 mA typical
- Dimensions : 57 (W) \times 153 (H) \times 35 (D) mm; 2 $\frac{1}{4}$ (W) \times 6 $\frac{1}{32}$ (H) \times 1 $\frac{3}{8}$ (D) in
(Projections not included)
- Weight : 465 g (16.4 oz) with CM-166 and antenna

■ TRANSMITTER

- Output power (at 12 V DC)* : 5.0 W typical (PEP power)
1.5 W typical (Carrier power)
- Modulation system : Low level modulation
- Microphone impedance : $150\ \Omega$
- Spurious emissions* : $-60\ \text{dB}$

■ RECEIVER

- Receive system : Double-conversion superheterodyne
- Intermediate frequency : 1st 35.8 MHz
2nd 455 kHz
- Sensitivity* : Less than $1\ \mu\text{V}$ for 6 dB S/N (with 1 kHz, 30 % modulation)
- Tight squelch sensitivity* : Less than $6.3\ \mu\text{V}$
- Selectivity* : More than 8 kHz/ $-6\ \text{dB}$
Less than 25 kHz/ $-60\ \text{dB}$
- Spurious response rejection* : $-60\ \text{dB}$
- Noise and hum : $-25\ \text{dB}$
- Audio output power* : 600 mW with an $8\ \Omega$ load
- Audio output impedance : $8\ \Omega$

*Specifications guaranteed at a transceiver temperature of $+25^{\circ}\text{C}$ ($+77^{\circ}\text{F}$).
All stated specifications are subject to change without notice or obligation.

SECTION 2 INSIDE VIEWS

• RF UNIT

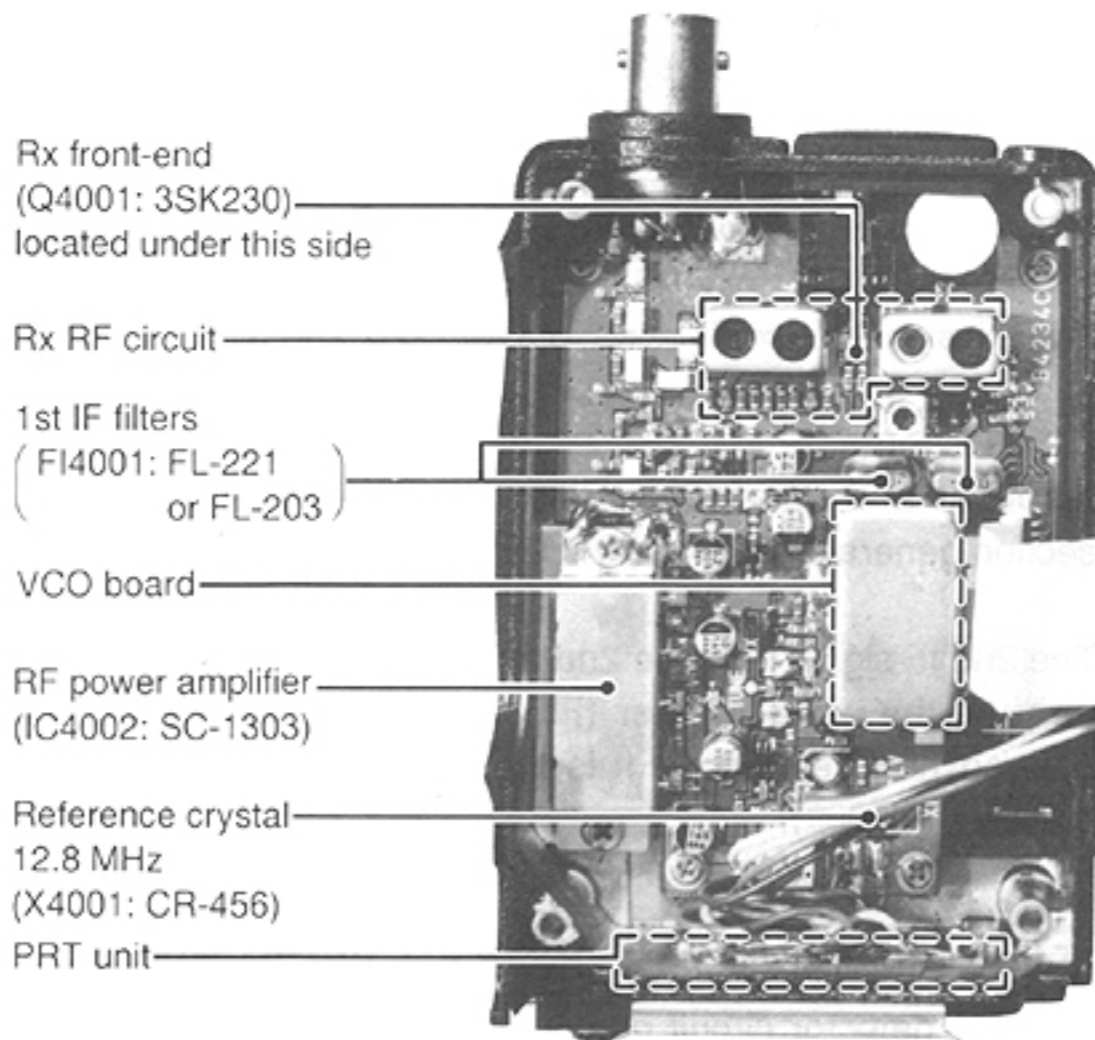

• MAIN UNIT (Side B)

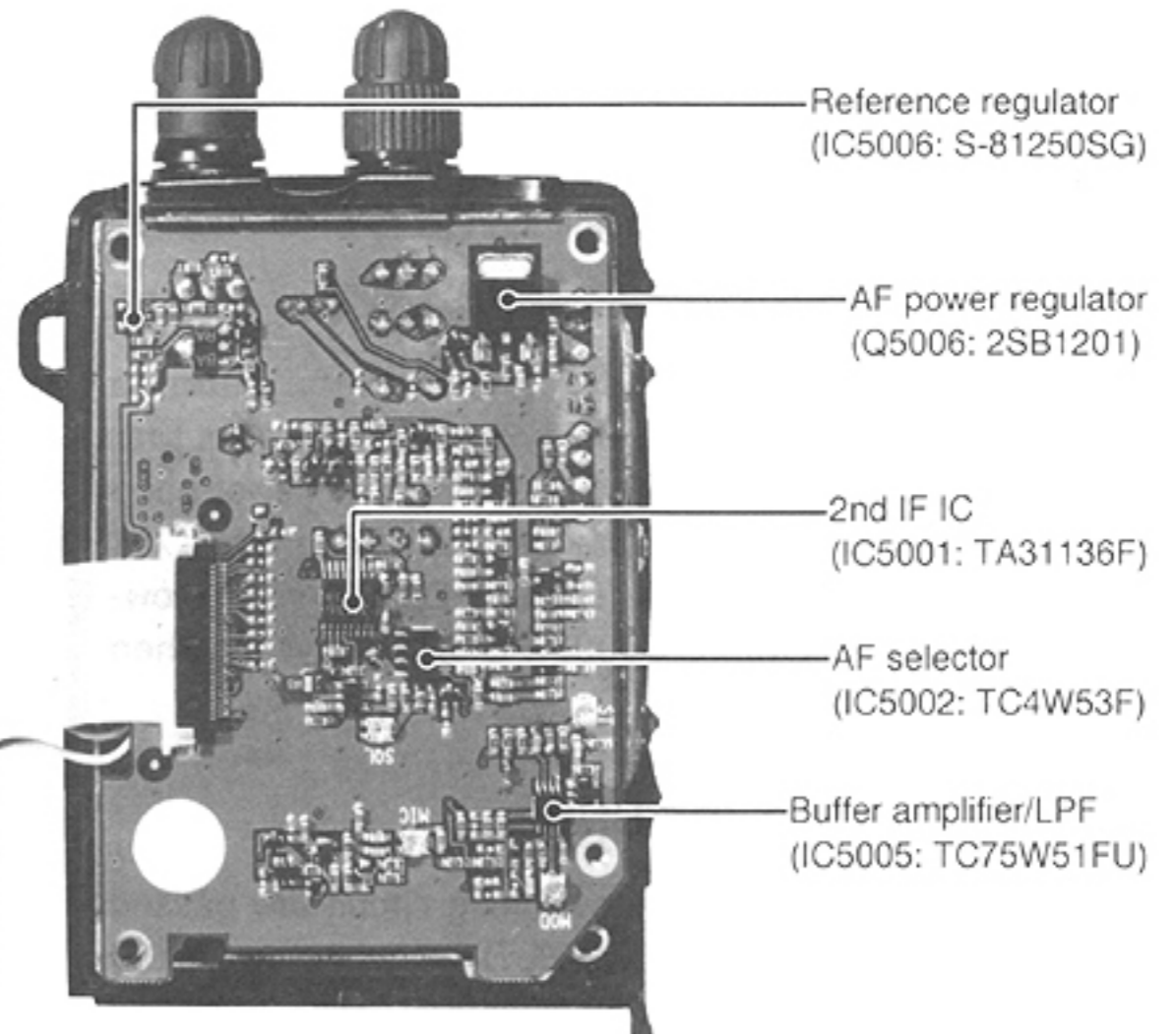

• MAIN UNIT (Side A)

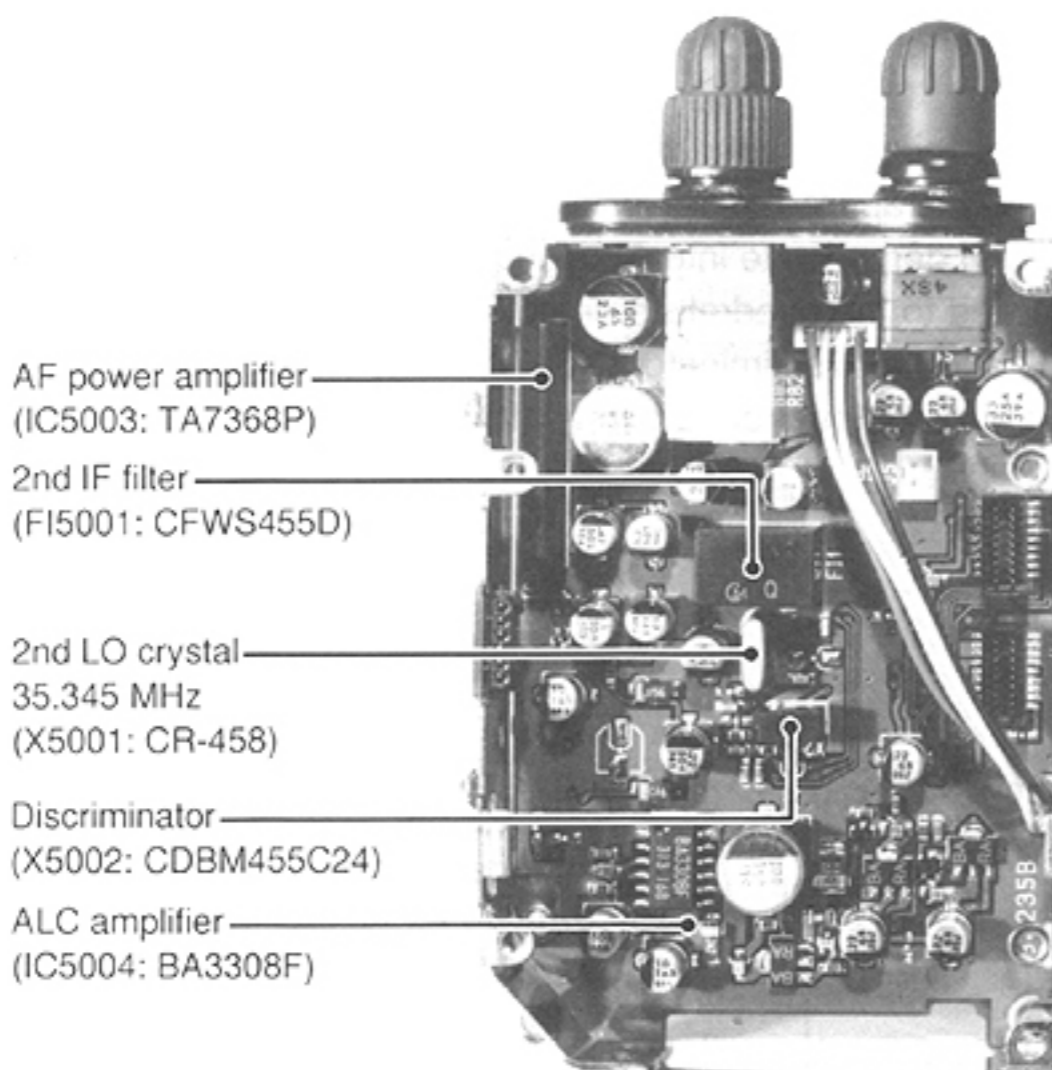

• LOGIC UNIT

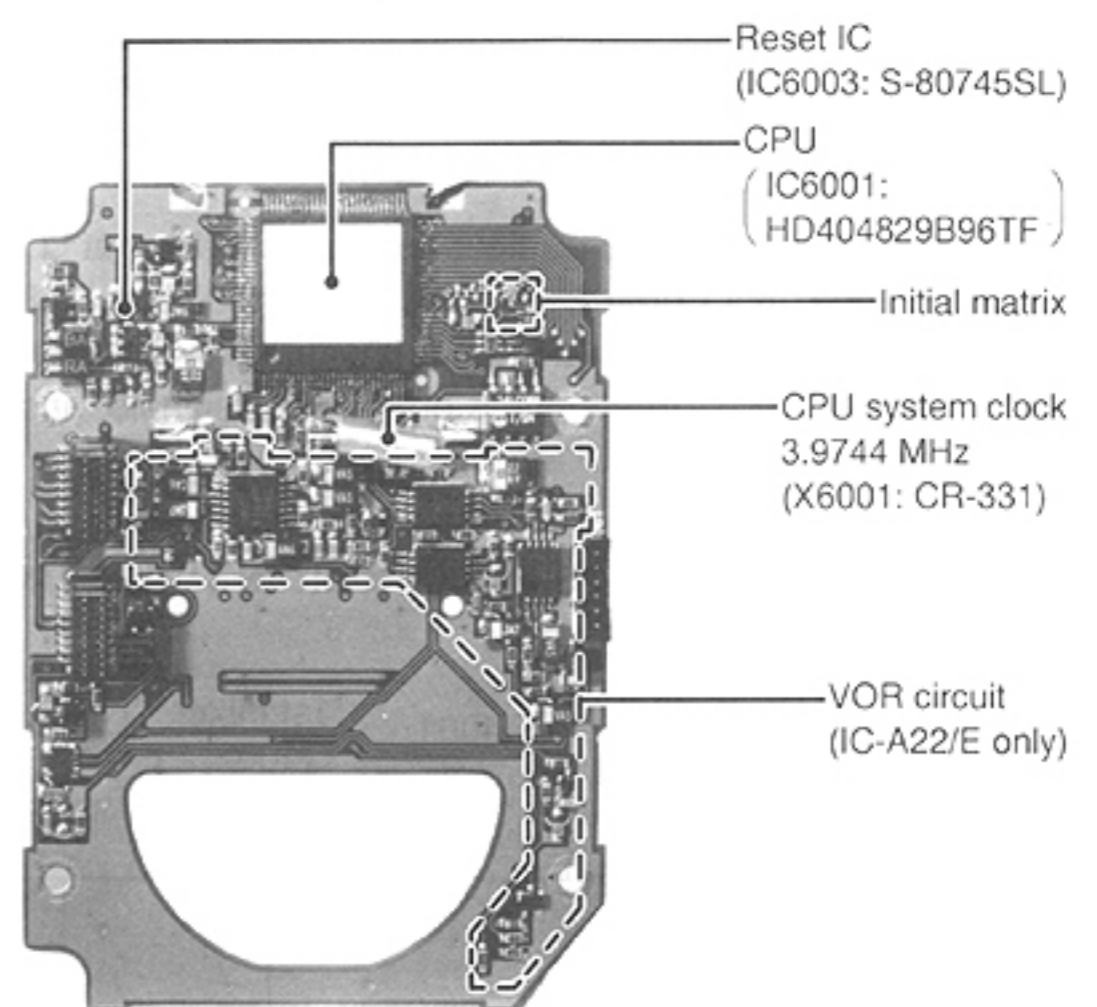

SECTION 3 CIRCUIT DESCRIPTION

3-1 RECEIVER CIRCUITS

3-1-1 ANTENNA SWITCHING CIRCUIT (RF UNIT)

The antenna switching circuit functions as a low-pass filter while receiving and a resonator circuit while transmitting. The circuit does not allow transmit signals to enter receiver circuits.

Received signals enter the RF unit from the antenna connector (J3001), and then pass through the low-pass filter (L4001–L4003, C4001–C4005) to suppress out-of-band signals. The filtered signals are passed through the $\lambda/4$ type antenna switching circuit (D4001–D4003) with a low-pass filter (L4004, L4005, C4007–C4009), and are then applied to the RF circuit.

3-1-2 RF CIRCUIT (RF UNIT)

The signals from the antenna switching circuit are passed through the bandpass filter (D4006, D4007, L4008, L4009) and amplified at the RF amplifier (Q4001). The amplified signals are again passed through the bandpass filter (D4008, D4009, L4010, L4011), and applied to the 1st mixer circuit.

D4006-D4009 are varactor diodes and are controlled by the PLL lock voltage. The voltage is buffer-amplified at Q4018 and is then applied to the varactor diodes. These varactor diodes tune the center frequency of an RF passband for wide bandwidth receiving and good image response rejection. For weather channel receiving, the tune voltage control circuit (Q4017, Q4019) supplies the bias voltage.

3-1-3 1ST MIXER AND 1ST IF CIRCUITS (RF UNIT)

The signals from the bandpass filter are mixed with a 1st LO signal from the VCO board, and are converted to a 35.8 MHz 1st IF signal. The 1st IF signal is applied to a pair of crystal filters (FI4001) to suppress out-of-band signals, and is then amplified at the 1st IF amplifier (Q4003).

3-1-4 2ND MIXER AND 2ND IF CIRCUITS (MAIN UNIT)

The 2nd mixer circuit converts the 1st IF signal to a 2nd IF signal. A double-conversion superheterodyne system improves the image rejection ratio and obtains stable receiver gain.

The 1st IF signal from the RF unit is applied to a 2nd mixer section of IC5001 (pin 16). The signal is then mixed with a 2nd LO signal for conversion to a 455 kHz 2nd IF signal.

IC5001 contains the 2nd mixer, local oscillator, limiter amplifier and quadrature detector. The local oscillator section generates 35.345 MHz using X5001.

The 2nd IF signal from the 2nd mixer (IC5001, pin 3) passes through the ceramic filter (FI5001) to remove unwanted heterodyned frequency. It is then amplified at the 2nd IF amplifier (Q5002).

3-1-5 AM DETECTOR CIRCUIT (MAIN UNIT)

The AM detector circuit demodulates an AM signal on the communication band or navigation band.

The 2nd IF signal from Q5002 is again amplified at IF amplifiers (Q5003, Q5030), and applied to the AM detector (Q5004). It is then detected for conversion to an AF signal.

3-1-6 FM DETECTOR CIRCUIT (MAIN UNIT)

The FM detector circuit demodulates an FM signal for weather channel receiving.

When receiving a weather channel, the 2nd IF signal from Q5002 is applied to the limiter amplifier section (IC5001, pin 5). To demodulate into AF signals, the 2nd IF signal is then applied to the quadrature detector section (IC5001, pins 10, 11) and the discriminator (X5002). The AF signal (detector signal) is output from the IF IC (IC5001, pin 9).

BLOCK DIAGRAM OF RECEIVER CIRCUIT IN THE RF UNIT

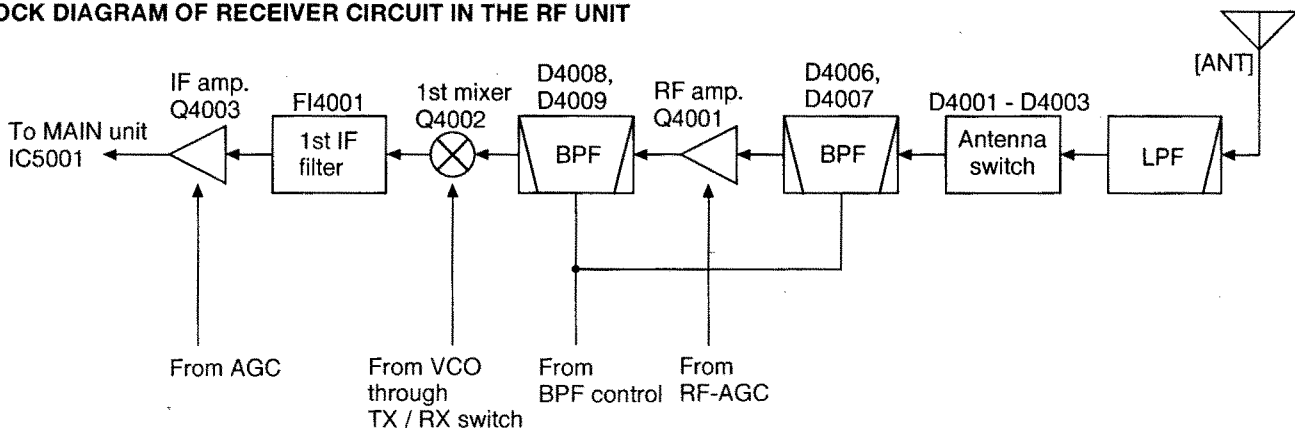

3-1-7 SQUELCH CIRCUIT (MAIN UNIT)

The squelch circuit cuts out AF signals when no RF signal is received.

A portion of the 2nd IF signal (from Q5002) is applied to the limiter amplifier section (IC5001, pin 5). Then the IF IC (IC5001) outputs a detected (IF level) signal from pin 12. This signal is applied to the comparator (IC5007), and is then compared with preset squelch voltage. Output from the comparator is applied to the AF selector (IC5002) as an SQL signal, and controls the AF signal line.

3-1-8 AF CIRCUIT (MAIN UNIT)

The AF circuit drives the speaker (SP3001).

AF signals from the detector circuit are selected at the AF selector (IC5002), and are passed through the AF filter (Q5026, Q5005) and volume control (R5082).

The signals are amplified at the AF power amplifier (IC5003) to a level needed to drive the speaker.

3-1-9 AGC CIRCUIT (MAIN UNIT)

The AGC (Automatic Gain Control) circuit reduces signal fading and keeps the audio output level constant.

AF signals from the detector circuit (Q5004) are converted into DC voltage at integral circuits (C5026/R5030, C5026/R5105), and are then applied to inversion amplifiers (Q5010, Q5031).

These amplifiers reduce the amplifier gain of IF amplifiers (Q5002, Q5003, Q4003) and the RF amplifier (Q4001) while receiving a strong signal.

3-1-10 ANL CIRCUIT (MAIN UNIT)

The ANL (Automatic Noise Limiter) circuit (D5003, Q5008, R5015 – R5018) reduces pulse noises.

The AM detector output signal (DETO) from Q5004 is applied to the cathode of D5003 passing through R5015 where it is divided by R5015 and R5016. The DETO signal is also applied to the anode of D5003, passing through R5017 and R5018.

When the ANL function is activated (Q5008 is ON), C5024 is grounded. The detector output, including pulse noise, is applied to the cathode of D5003 only. If pulse noises are received, the cathode voltage of D5003 becomes higher than the anode voltage and D5003 turns OFF. Thus, while pulse noises are received, the detected signal is not applied to IC5002.

ANL CIRCUIT

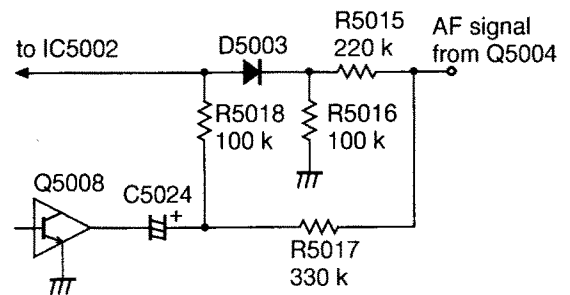

3-1-11 VOR CIRCUIT (LOGIC UNIT) [IC-A22/E only]

From the AF signal, the VOR circuit detects a variable signal (VORC) and reference signal (VORS) from a VOR station. The VOR circuit sends these signals to the CPU (IC6001).

When the transceiver is set in the navigation band (108.000 – 117.975 MHz), the NAV port (IC6001, pin 43) becomes "HIGH" turning the VOR circuit ON via Q6108. Q6108 controls a 5 V power source for the VOR circuit.

VOR CIRCUIT BLOCK DIAGRAM

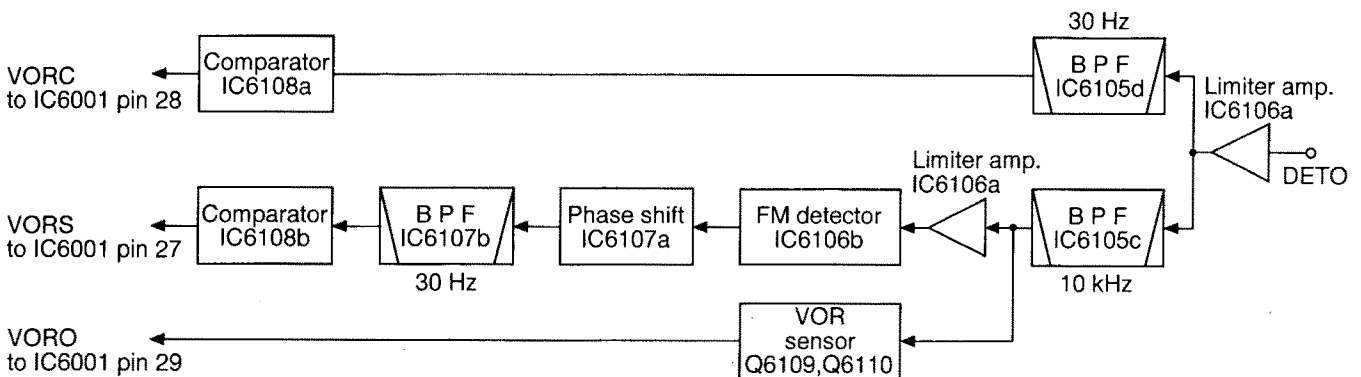

The signal from the AM detector (DETO) is buffer amplified at the VOR amplifier (IC6105b).

The DETO signal includes 30 Hz variable phase components and 9960 Hz reference phase components.

The 30 Hz component passes through the 30 Hz bandpass filter (IC6105d), and is converted to a square-wave signal at the VORC comparator (IC6108a). The square-wave signal is then applied to IC6001 (pin 28) as a variable signal (VORC).

The 9960 Hz component passes through the 10 kHz bandpass filter (IC6105c). These components are FM modulated with 480 Hz deviation and 30 Hz modulation.

Signals are then amplified at a limiter amplifier (IC6106a), and detected at an FM detector (IC6106b) to obtain a 30 Hz reference signal.

The 30 Hz signal is compensated on phase at IC6107a. This signal is passed through the 30 Hz bandpass filter (IC6107b) and is converted to a square-wave signal at the VORS comparator (IC6108b). This signal is applied to IC6001 (pin 27) as a reference signal (VORS).

A portion of output from IC6105c is applied to the VOR sensor (Q6109, Q6110). When VOR signal level is low, the output from IC6105c is reduced. Q6110 cannot be turned ON, then IC6001 (pin 29) receives "HIGH" to indicate "OFF FLAG" indicator.

3-2 TRANSMITTER CIRCUITS

3-2-1 MICROPHONE AMPLIFIER CIRCUIT (MAIN UNIT)

AF signals from the microphone or from the [MIC] jack are applied to the ALC amplifier (IC5004, pin 9) through R5047. R5047 adjusts the microphone input level.

The output signal from IC5004 (pin 7) are amplified at the buffer amplifier (IC5005b) and low-pass filter (IC5005a). The signal (MOD) is applied to the AM modulator (D4002) on the RF unit.

When using a headset, the SIDET signal from Q4020 becomes "HIGH," turning IC5008 ON. Then a portion of amplified signal from IC5005b is applied to the AF power amplifier as a monitor signal.

3-2-2 MODULATION CIRCUIT (RF UNIT)

Using the MOD signal from the microphone amplifier circuit, the modulation circuit modulates Tx LO signal from the VCO.

During transmission, the LO signal from the VCO board is output through buffer amplifiers (Q4004, Q4005) and Tx/Rx switch (D4010). This signal is then applied to the AM modulator (D4012).

Q4006 amplifies the LO signal with a gain controlled by an AF signal (MOD) to make low level modulation.

3-2-3 DRIVE/POWER AMPLIFIER CIRCUITS (RF UNIT)

The modulated RF signal from Q4006 is amplified by the pre-drive amplifier (Q4007) and the power amplifier (IC4002) in sequence to obtain 5 W (at 12 V DC) of RF power. The amplified signal is passed through the antenna switching circuit (D4003) and low-pass filter (L4001–L4003, C4001–C4005) and is then applied to the antenna connector (J3001).

3-2-4 APC CIRCUIT (MAIN UNIT)

The APC circuit protects the power amplifier (IC4002) from a mismatched output load.

The APC detector circuit (D4005, L4006, D4004) detects forward signals and rectified signals at D4005 and D4004 respectively. The combined voltage is at a minimum level when the antenna is matched at 50Ω, and is increased when it is mismatched.

The detected voltage is applied to one of the differential amplifier input (Q4010) and a power setting voltage is applied to the other input. When the antenna impedance is mismatched, the detected voltage exceeds the APC output current via Q4014 to decrease the output power.

The current of the APC attenuator (D4013) is controlled by the APC circuit to protect the power amplifier from a mismatched condition as well as stabilize the output power.

APC CIRCUIT

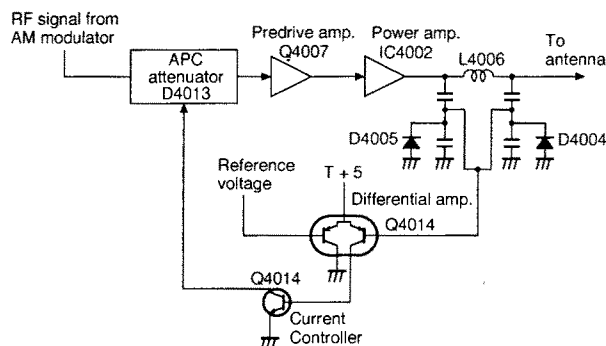

3-3 PLL CIRCUITS

3-3-1 GENERAL (RF UNIT)

A PLL circuit provides stable oscillation of the transmitting frequency and the receiving frequency. The PLL output frequency is controlled by the divided ratio (N-data) of the programmable divider.

3-3-2 VCO CIRCUIT (VCO BOARD)

The VCO (Q7001, Q7002, D7001) employs an oscillation circuit. Frequency shifting for transmitting (or weather channel receiving) and receiving is performed by changing the bias voltage of D7002.

LO signals generated by the VCO are amplified at the buffer amplifier (Q7003), and are then applied to the 1st mixer (Q4002) or AM modulator (D4012) through buffer amplifiers (Q4004, Q4005) and Tx/Rx switch (D4010, D4021). Signals from Q7003 are also applied to the PLL IC (IC4001) through a buffer amplifier (Q4015).

3-3-3 PROGRAMMABLE DIVIDER (RF UNIT)

Signals from Q4015 are input into the PLL IC (IC4001, pin 2), and divided N times at the programmable divider section. The divided signals are detected on phase at the phase detector section using the reference frequency. The output signal from the phase detector is passed through the charge pump, and is output from pin 8.

The output signal (error pulse) from pin 8 passes through a loop filter (R4064, R4065, C4102, C4104) and changes DC voltage. This signal is applied to the VCO board as the PLL lock voltage (LV).

The output signal from pin 8 is also applied to the BPF control circuit (Q4018, D4019) to change the center frequency of the receiver bandpass filters.

PLL CIRCUIT BLOCK DIAGRAM

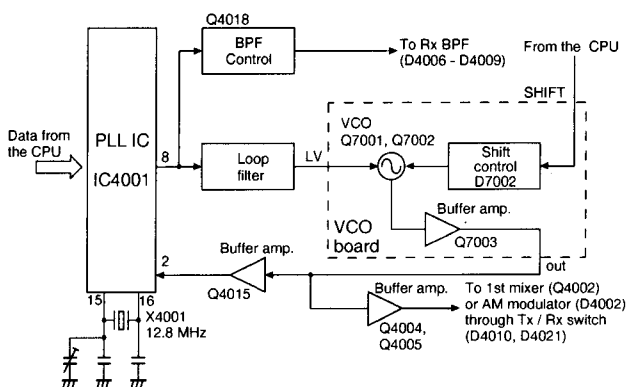

3-4 POWER SUPPLY CIRCUITS

LINE	DESCRIPTION
HV	Voltage line from the attached battery pack or the [DC 12V] jack.
VCC	The same voltage as the HV line which is controlled by [POWER] switch.
5V	Common 5 V converted from the VCC line by the 5V regulator circuit (Q5014, Q5015, D5005) using the reference regulator (IC5006) on the MAIN unit.
+5	Common 5 V converted from the VCC line by the +5 regulator circuit (Q5016, Q5017, D5006) using 5V line as the reference voltage.
R5	5 V for receiver circuit converted from the VCC line by the R5 regulator circuit (Q5019, Q5020, D5007). R5 is controlled by Q5018 using TRC signal from the CPU (IC6001).
T+5	5 V for transmitter circuit controlled by the TMUT signal from the CPU (IC6001). T+5 regulator circuit is located on the RF unit and consists of Q4012, Q4013 and D4016.

3-5 CPU PORT ALLOCATIONS

PIN NO.	PORT NAME	DESCRIPTION
2	LBATT	Input port for detecting the connected battery (or external DC input) voltage for "LOW BATT" or "OVER V" indication
3	SQL	Input port for the squelch condition When squelch open: Low
4	LOK	Input port for the PLL condition When PLL in unlocked: High
14	CLK	Outputs a clock signal to the PLL IC (IC4001).
15	DATA	Outputs N-data to the PLL IC.
16	ENB	Outputs a strobe signal to the PLL IC.
17	SCL	Outputs a clock signal to the EEPROM (IC6002).
18	SDA	Outputs data to the EEPROM.
19	UP	Input port for the tuning dial "UP" clock
20	DOWN	Input port for the tuning dial "DOWN" clock
21	LIGHT	Outputs a backlit control signal for the LCD and keypad. High: for lighting
22	BEEP	Outputs beep signals.
23	CLONE	Outputs clone data.
24	PTT	Input port for the PTT switch When PTT is pushed: High
25	CLONE	Input port for the clone reading
26	BACK UP	Input port for the CPU backup signal
27	VORS *	Input port for the VOR reference signal
28	VORC *	Input port for the VOR variable signal
29	VORO *	Input port for the VOR level signal
30-33	R10-R13	Output ports for the key matrix
34-37	R20-R30	Input port for the key matrix
38-41	R31-R33	Input port for the initial matrix
42	WX	Outputs the WX control signal. High: when a WX channel is selected.
43	NAV *	Outputs the navigation channel signal. High: when a NAV channel is selected.
44	ANL	Outputs the ANL signal. High: to activate the ANL function
46	AFON	Outputs the AF power amplifier control signal. High: to activate the amplifier
47	TRC	Outputs a Tx/Rx control signal. High: for Tx
48	TMUT	Outputs a Tx mute signal. Low: for muting
49	SHIFT	Outputs a "shift" signal for VCO oscillating frequency.
50-93	SEG13-52, COM1-4	Output ports for the LCD drive

Note: Marked * in the PORT NAME column for IC-A22/E only

SECTION 4 ADJUSTMENT PROCEDURES

4-1 PLL AND TRANSMITTER ADJUSTMENTS

ADJUSTMENT		ADJUSTMENT CONDITIONS	MEASUREMENT		VALUE	ADJUSTMENT POINT	
			UNIT	LOCATION		UNIT	ADJUST
TUNE VOLTAGE	1	<ul style="list-style-type: none"> • Displayed frequency: 118.025 MHz • Receiving 	RF	Connect the digital multimeter or oscilloscope to CP2 (TUNE).	1.5±0.1 V	RF	R4068
REFERENCE FREQUENCY	1	<ul style="list-style-type: none"> • Displayed frequency: 136.975 MHz • Connect the RF power meter or a 50 Ω dummy load to the antenna connector. • Transmitting 	Top panel	Loosely couple the frequency counter to the antenna connector.	136.975 MHz	RF	C4101
POWER	1	<ul style="list-style-type: none"> • Displayed frequency: 118.025 MHz • Apply no AF signal to the [MIC] jack. • Transmitting 	Top panel	Connect the RF power meter to the antenna connector.	1.5 W (Carrier power)	RF	R4057
MODULATION	1	<ul style="list-style-type: none"> • Displayed frequency: 136.975 MHz • R5047, R5098: Center • Apply an AF signal to the [MIC] jack. 1 kHz/200 mV • Transmitting 	Top panel	Connect the modulation analyzer to the antenna connector via an attenuator.	85%	MAIN	R5098
	2	<ul style="list-style-type: none"> • Apply an AF signal to the [MIC] jack. 1 kHz/20 mV 			30%	MAIN	R5047
	3	<ul style="list-style-type: none"> • Apply an AF signal to the [MIC] jack. 1 kHz/200 mV 	Top panel	Connect the AC multivoltmeter with an 8Ω dummy load to the [SP] jack.	400 mV	MAIN	R5087

• RF UNIT

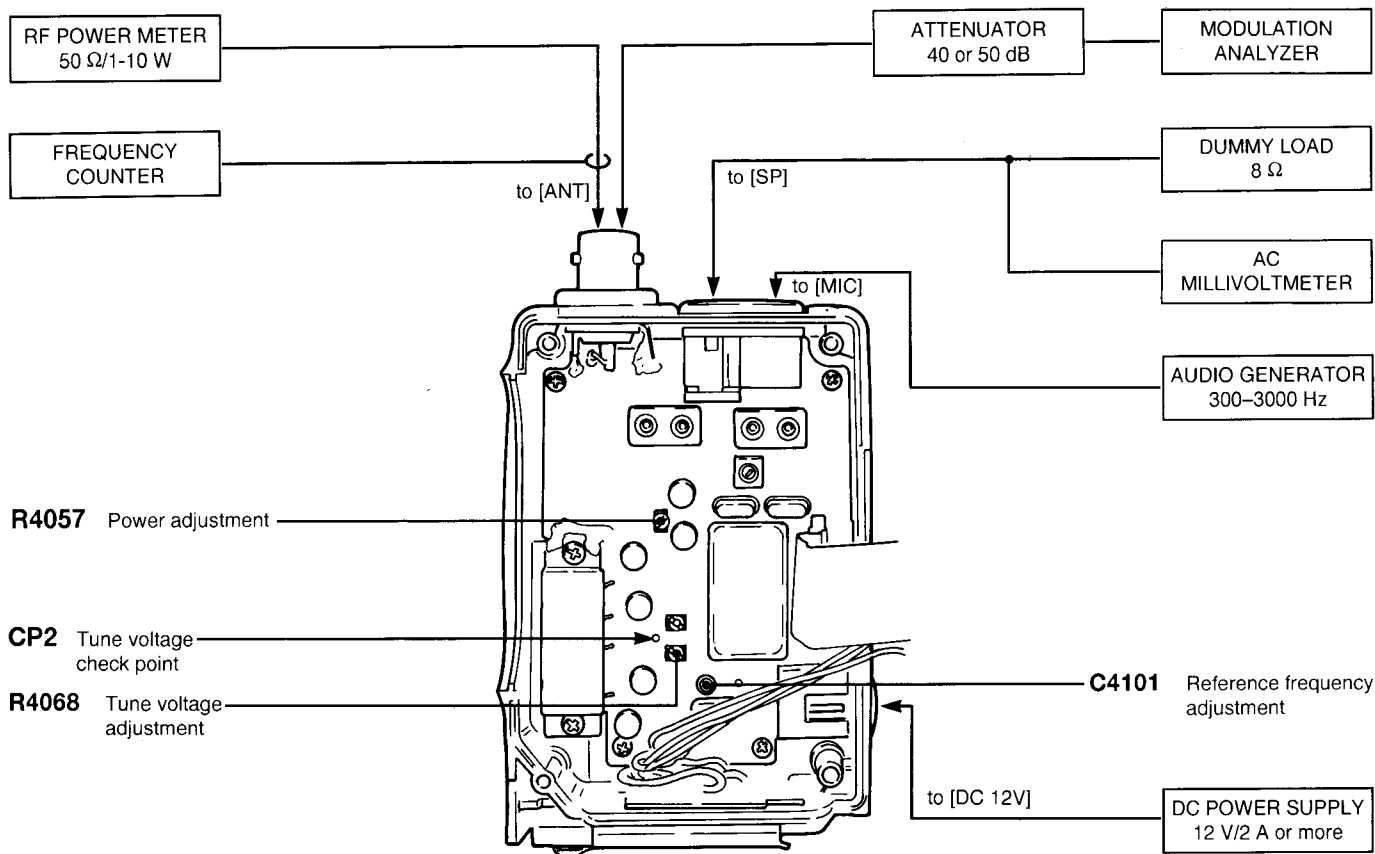

• MAIN UNIT

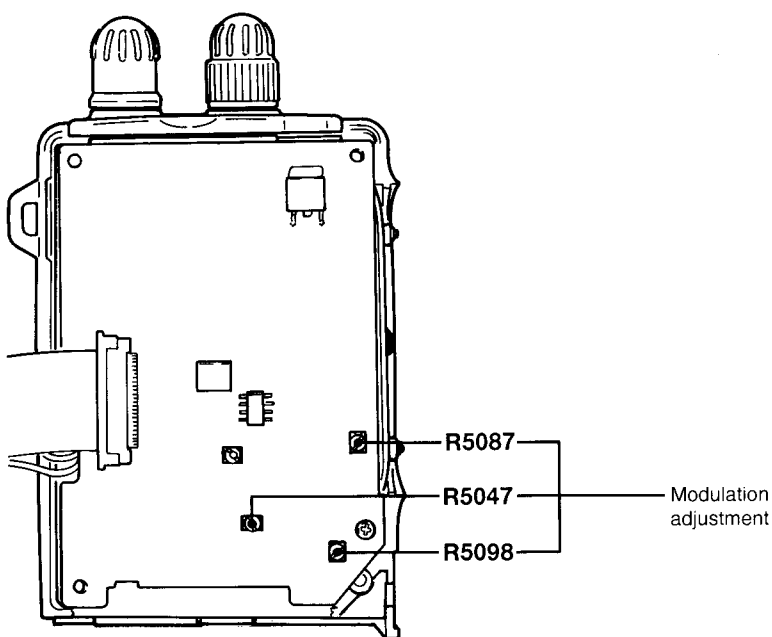

4-2 RECEIVER ADJUSTMENT

ADJUSTMENT	ADJUSTMENT CONDITIONS	MEASUREMENT		VALUE	ADJUSTMENT POINT	
		UNIT	LOCATION		UNIT	ADJUST
SENSITIVITY	1 <ul style="list-style-type: none"> • Displayed frequency: 118.025 MHz • Connect the SSG to the antenna connector and set as: Frequency: 118.025 MHz Level: 1.0 μV* (-107 dBm) Modulation: AM, 1 kHz, 30 % • Receiving 	Top panel	Connect the AC millivoltmeter with an 8 Ω dummy load to the [SP] jack.	Maximum audio output	RF	L4008–L4011
	2 <ul style="list-style-type: none"> • Displayed frequency: 136.975 MHz • Set the SSG as: Frequency: 136.975 MHz 					R4068, L4012
WEATHER CHANNEL SENSITIVITY (USA version only)	1 <ul style="list-style-type: none"> • Displayed frequency: Weather ch. 01 • Connect the SSG to the antenna connector and set as: Frequency: 162.550 MHz Level: 0.56 μV* (-112 dBm) FM deviation: \pm3.5 kHz Modulation: 1 kHz • Receiving 	Top panel	Connect the SINAD meter to the [SP] jack.	SINAD peak	RF	R4067
SQUELCH	1 <ul style="list-style-type: none"> • Displayed frequency: 118.025 MHz • Connect the SSG to the antenna connector and set as: Frequency: 118.025 MHz Level: 2.0 μV* (-101 dBm) Modulation: AM, 1 kHz, 30 % • [SQL] control: Max. counterclockwise • Receiving 	Front panel	Speaker	Squelch just closes.	MAIN	R5114
VOR (IC-A22/E only)	1 <ul style="list-style-type: none"> • Set the IC-A22/E to the VOR setting condition: while pushing [1] and [9], turn power ON. • Displayed frequency: 113.000 MHz • Connect the SSG to the antenna connector and set as: Frequency: 113.000 MHz Level: 0.22 mV* (-60 dBm) Modulation: 9960 Hz, 30 % 30 Hz, 30 % Bearing: FROM, 90° • R6150: Center • Receiving 	Front panel	Function display	"FROM, 90°" \pm 3°	LOGIC	R6151
	2			"FROM, 90°"		R6150
	3 <ul style="list-style-type: none"> • Set the SSG as: Level: 7.1 μV* (-90 dBm) Modulation: 9960 Hz, 15 % 30 Hz, 30 % 			Course indicator just appears.		R6135

*This output level of the standard signal generator (SSG) is indicated as SSG's open circuit.

● RF UNIT

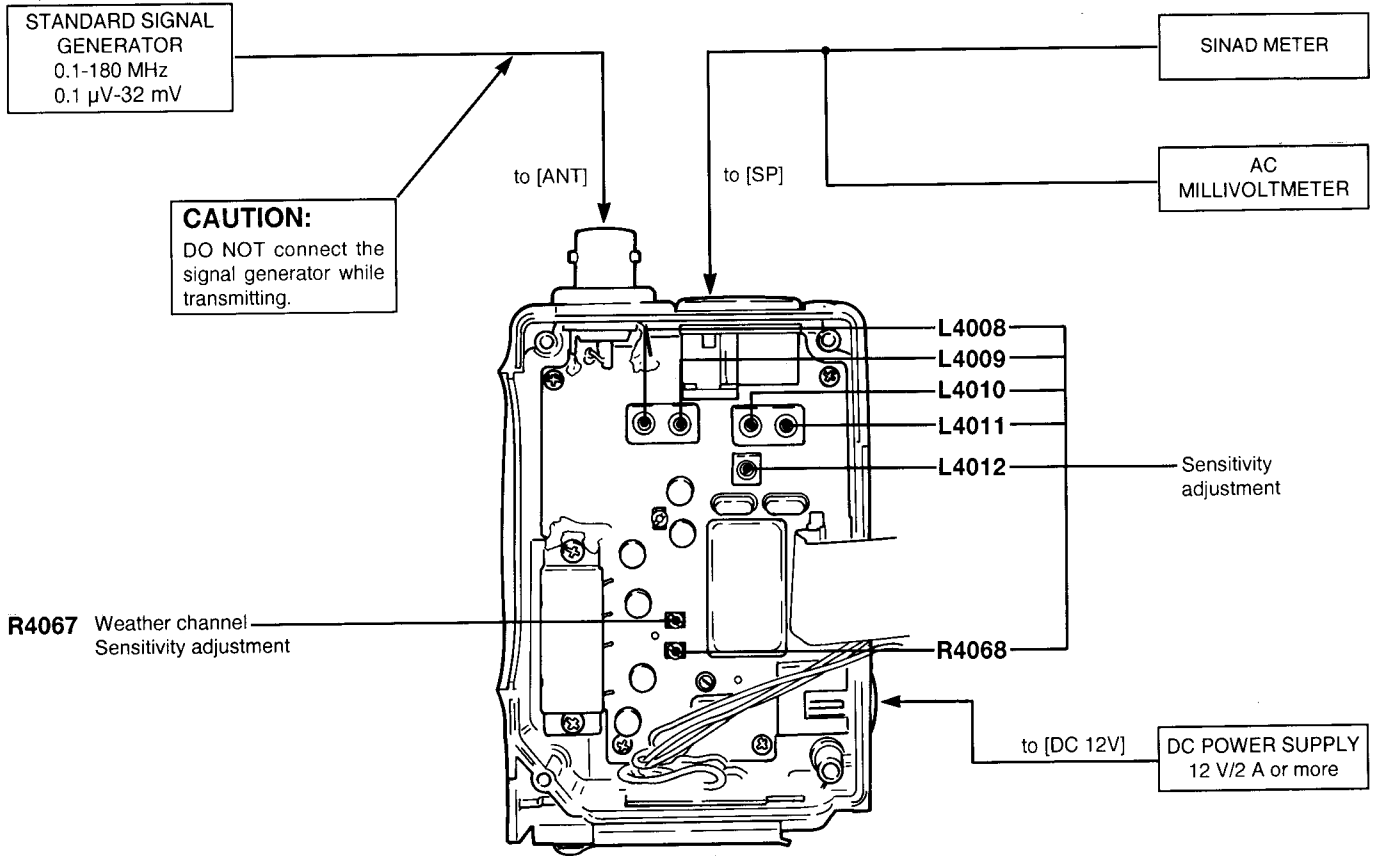

● LOGIC UNIT (for IC-A22/E)

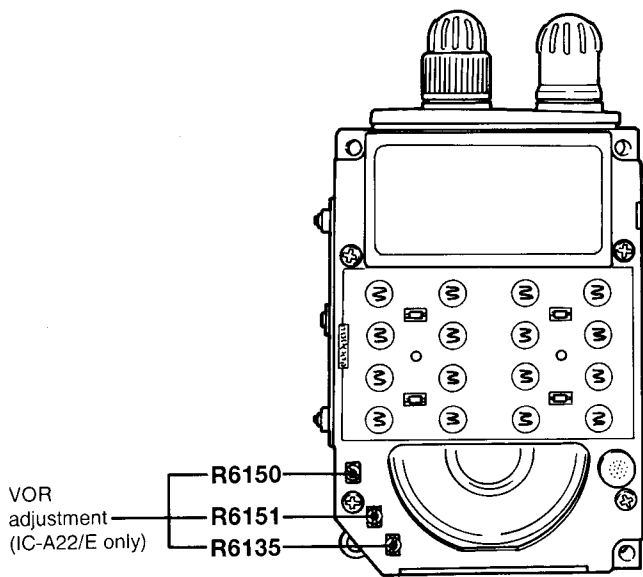

● MAIN UNIT

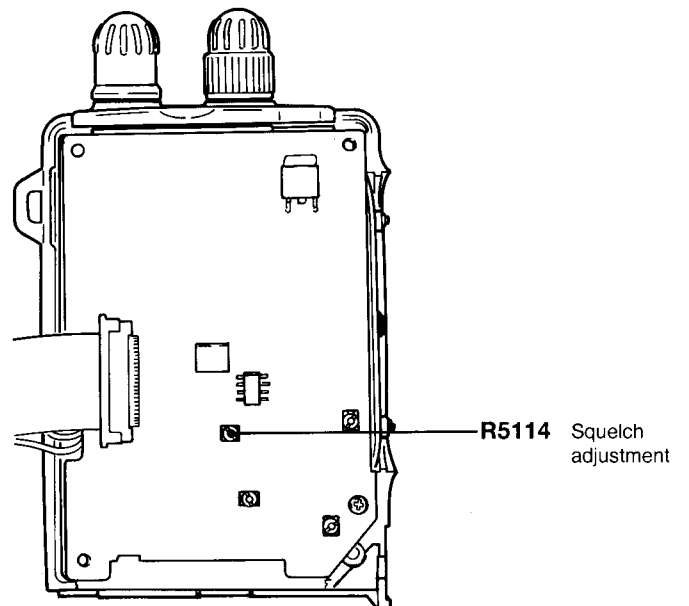

SECTION 5 PARTS LIST

[RF UNIT]

REF. NO.	ORDER NO.	DESCRIPTION	
IC4001	1130007810	S.IC	μ PD3140GS-E1 (DS8)
IC4002	1110003680	IC	SC1303
Q4001	1580000650	S.FET	3SK230-T2 U1B
Q4002	1580000400	S.FET	3SK151-Y (TE85R)
Q4003	1530002600	S.TRANSISTOR	2SC4215-O (TE85R)
Q4004	1530002560	S.TRANSISTOR	2SC4403-3-TR
Q4005	1530002560	S.TRANSISTOR	2SC4403-3-TR
Q4006	1530002560	S.TRANSISTOR	2SC4403-3-TR
Q4007	1530003340	S.TRANSISTOR	2SC3357-T2 RF
Q4010	1590001160	S.TRANSISTOR	XP1401-(TX).AB
Q4011	1590001140	S.TRANSISTOR	UN9210(TX)
Q4012	1530003280	S.TRANSISTOR	2SC4211-6-TR
Q4013	1520000460	S.TRANSISTOR	2SB1132 T100 R
Q4014	1530003280	S.TRANSISTOR	2SC4211-6-TR
Q4015	1530002560	S.TRANSISTOR	2SC4403-3-TR
Q4016	1590001140	S.TRANSISTOR	UN9210(TX)
Q4017	1590001130	S.TRANSISTOR	UN9110(TX)
Q4018	1590001650	S.TRANSISTOR	XP4601(TX)
Q4019	1590001140	S.TRANSISTOR	UN9210(TX)
Q4020	1590001650	S.TRANSISTOR	XP4601(TX)
Q4021	1530002850	S.TRANSISTOR	2SC4116-BL (TE85R)
D4001	1790000620	S.DIODE	MA77(TW)
D4002	1790000620	S.DIODE	MA77(TW)
D4003	1790000620	S.DIODE	MA77(TW)
D4004	1790000680	S.DIODE	MA728(TW)
D4005	1790000680	S.DIODE	MA728(TW)
D4006	1790001290	S.VARICAP	MA304(TX)
D4007	1790001290	S.VARICAP	MA304(TX)
D4008	1790001290	S.VARICAP	MA304(TX)
D4009	1790001290	S.VARICAP	MA304(TX)
D4010	1790000620	S.DIODE	MA77(TW)
D4012	1750000460	S.DIODE	1SV246-TR
D4013	1750000460	S.DIODE	1SV246-TR
D4016	1790001280	S.DIODE	MA111(TX)
D4017	1730002300	S.ZENER	MA8082-M(TX)
D4018	1790000850	S.DIODE	MA132WK(TX)
D4019	1790000860	S.DIODE	MA133(TX)
D4020	1790001030	S.DIODE	SB30-03P-TD
D4021	1790000620	S.DIODE	MA77(TW)
D4022	1790001330	S.ZENER	MA8036-L(TX)
D4025	1790001030	S.DIODE	SB30-03P-TD
FI4001	2010001830	FILTER	FL-221 (35.800MHz) [IC-A22]
	2010001830	FILTER	FL-203 (35.800MHz) [IC-A3]
X4001	6050008730	XTAL	CR-456 (12.8 MHz)
L4001	6200002820	S.COIL	LQN 1A 47NJ04
L4002	6200002390	S.COIL	LQN 1A 64NJ04
L4003	6200002390	S.COIL	LQN 1A 64NJ04
L4004	6200002380	S.COIL	LQN 1A 56NJ04
L4005	6200002820	S.COIL	LQN 1A 47NJ04
L4006	6200002380	S.COIL	LQN 1A 56NJ04
L4007	6200001520	S.COIL	MLF2012D R82K-T
L4008	6130001740	COIL	LB-170
L4009	6130001750	COIL	LB-172
L4010	6130002850	COIL	LB-326
L4011	6130001750	COIL	LB-172
L4012	6150004390	S.COIL	LS-492
L4014	6200001920	S.COIL	ELJNC R15K-F
L4015	6200001920	S.COIL	ELJNC R15K-F

[RF UNIT]

REF. NO.	ORDER NO.	DESCRIPTION	
L4016	6200001630	S.COIL	ELJNC R10K-F
L4017	6200002390	S.COIL	LQN 1A 64NJ04
L4025	6200002190	S.COIL	MLF2012A 4R7K-T
L4027	6200002190	S.COIL	MLF2012A 4R7K-T
L4028	6200003550	S.COIL	MLF1608A 4R7K-T
R4001	7030003320	S.RESISTOR	ERJ3GEYJ 101 V (100 Ω)
R4004	7030003370	S.RESISTOR	ERJ3GEYJ 271 V (270 Ω)
R4005	7030003370	S.RESISTOR	ERJ3GEYJ 271 V (270 Ω)
R4006	7030003620	S.RESISTOR	ERJ3GEYJ 333 V (33 kΩ)
R4007	7030003720	S.RESISTOR	ERJ3GEYJ 224 V (220 kΩ)
R4008	7030003720	S.RESISTOR	ERJ3GEYJ 224 V (220 kΩ)
R4009	7030003720	S.RESISTOR	ERJ3GEYJ 224 V (220 kΩ)
R4010	7030003680	S.RESISTOR	ERJ3GEYJ 104 V (100 kΩ)
R4011	7030003640	S.RESISTOR	ERJ3GEYJ 473 V (47 kΩ)
R4012	7030003280	S.RESISTOR	ERJ3GEYJ 470 V (47 Ω)
R4013	7030003280	S.RESISTOR	ERJ3GEYJ 470 V (47 Ω)
R4014	7030003720	S.RESISTOR	ERJ3GEYJ 224 V (220 kΩ)
R4015	7030003720	S.RESISTOR	ERJ3GEYJ 224 V (220 kΩ)
R4016	7030003760	S.RESISTOR	ERJ3GEYJ 474 V (470 kΩ)
R4017	7030003670	S.RESISTOR	ERJ3GEYJ 823 V (82 kΩ)
R4018	7030003560	S.RESISTOR	ERJ3GEYJ 103 V (10 kΩ)
R4019	7030003200	S.RESISTOR	ERJ3GEYJ 100 V (10 Ω)
R4020	7030003560	S.RESISTOR	ERJ3GEYJ 103 V (10 kΩ)
R4021	7030003320	S.RESISTOR	ERJ3GEYJ 101 V (100 Ω)
R4022	7030003410	S.RESISTOR	ERJ3GEYJ 561 V (560 Ω)
	7030003390	S.RESISTOR	ERJ3GEYJ 391 V (390 Ω)
R4023	7030003770	S.RESISTOR	ERJ3GEYJ 564 V (560 kΩ)
R4024	7030003480	S.RESISTOR	ERJ3GEYJ 222 V (2.2 kΩ)
R4025	7030003500	S.RESISTOR	ERJ3GEYJ 332 V (3.3 kΩ)
R4027	7030003220	S.RESISTOR	ERJ3GEYJ 150 V (15 Ω)
R4028	7030003220	S.RESISTOR	ERJ3GEYJ 150 V (15 Ω)
R4029	7030003460	S.RESISTOR	ERJ3GEYJ 152 V (1.5 kΩ)
R4030	7030003610	S.RESISTOR	ERJ3GEYJ 273 V (27 kΩ)
R4031	7030003340	S.RESISTOR	ERJ3GEYJ 151 V (150 Ω)
R4032	7030003610	S.RESISTOR	ERJ3GEYJ 273 V (27 kΩ)
R4033	7030003340	S.RESISTOR	ERJ3GEYJ 151 V (150 Ω)
R4034	7030003560	S.RESISTOR	ERJ3GEYJ 103 V (10 kΩ)
R4035	7030003560	S.RESISTOR	ERJ3GEYJ 103 V (10 kΩ)
R4036	7030003560	S.RESISTOR	ERJ3GEYJ 103 V (10 kΩ)
R4037	7030003560	S.RESISTOR	ERJ3GEYJ 103 V (10 kΩ)
R4039	7030003620	S.RESISTOR	ERJ3GEYJ 333 V (33 kΩ)
R4040	7030003580	S.RESISTOR	ERJ3GEYJ 153 V (15 kΩ)
R4041	7030003360	S.RESISTOR	ERJ3GEYJ 221 V (220 Ω)
R4042	7030003440	S.RESISTOR	ERJ3GEYJ 102 V (1 kΩ)
R4043	7030003440	S.RESISTOR	ERJ3GEYJ 102 V (1 kΩ)
R4044	7030003480	S.RESISTOR	ERJ3GEYJ 222 V (2.2 kΩ)
R4045	7030003440	S.RESISTOR	ERJ3GEYJ 102 V (1 kΩ)
R4047	7030003290	S.RESISTOR	ERJ3GEYJ 560 V (56 Ω)
R4054	7030003560	S.RESISTOR	ERJ3GEYJ 103 V (10 kΩ)
R4056	7030003660	S.RESISTOR	ERJ3GEYJ 683 V (68 kΩ)
R4057	7310003600	S.TRIMMER	EVM-1XSX50 B54 (503)
R4058	7030003600	S.RESISTOR	ERJ3GEYJ 223 V (22 kΩ)
R4059	7030003560	S.RESISTOR	ERJ3GEYJ 103 V (10 kΩ)
R4060	7030003560	S.RESISTOR	ERJ3GEYJ 103 V (10 kΩ)
R4061	7030003650	S.RESISTOR	ERJ3GEYJ 563 V (56 kΩ)
R4064	7030003440	S.RESISTOR	ERJ3GEYJ 102 V (1 kΩ)
R4065	7030003480	S.RESISTOR	ERJ3GEYJ 222 V (2.2 kΩ)
R4066	7030003440	S.RESISTOR	ERJ3GEYJ 102 V (1 kΩ)
R4067	7310003610	S.TRIMMER	EVM-1XSX50 B14 (103)
R4068	7310003610	S.TRIMMER	EVM-1XSX50 B14 (103)
R4069	7030003560	S.RESISTOR	ERJ3GEYJ 103 V (10 kΩ)
R4070	7030003420	S.RESISTOR	ERJ3GEYJ 681 V (680 Ω)
R4071	7030003660	S.RESISTOR	ERJ3GEYJ 104 V (100 kΩ)
R4072	7030003660	S.RESISTOR	ERJ3GEYJ 104 V (100 kΩ)
R4073	7030003360	S.RESISTOR	ERJ3GEYJ 221 V (220 Ω)
R4079	7030003640	S.RESISTOR	ERJ3GEYJ 473 V (47 kΩ)
R4080	7030003760	S.RESISTOR	ERJ3GEYJ 474 V (470 kΩ)
R4084	7030003400	S.RESISTOR	ERJ3GEYJ 471 V (470 Ω)

S.=Surface mount

[RF UNIT]

REF. NO.	ORDER NO.	DESCRIPTION	
R4086	7030003400	S.RESISTOR	ERJ3GEYJ 471 V (470 Ω)
R4087	7030003330	S.RESISTOR	ERJ3GEYJ 121 V (120 Ω)
R4088	7030003330	S.RESISTOR	ERJ3GEYJ 121 V (120 Ω)
R4089	7030003290	S.RESISTOR	ERJ3GEYJ 560 V (56 Ω)
R4090	7030003320	S.RESISTOR	ERJ3GEYJ 101 V (100 Ω)
R4091	7030003320	S.RESISTOR	ERJ3GEYJ 101 V (100 Ω)
R4092	7030003430	S.RESISTOR	ERJ3GEYJ 821 V (820 Ω)
R4093	7030003300	S.RESISTOR	ERJ3GEYJ 680 V (68 Ω)
R4094	7030003300	S.RESISTOR	ERJ3GEYJ 680 V (68 Ω)
R4095	7030003360	S.RESISTOR	ERJ3GEYJ 221 V (220 Ω)
R4096	7030003480	S.RESISTOR	ERJ3GEYJ 222 V (2.2 kΩ)
R4097	7030003770	S.RESISTOR	ERJ3GEYJ 564 V (560 kΩ)
R4098	7030003680	S.RESISTOR	ERJ3GEYJ 104 V (100 kΩ)
R4099	7030003620	S.RESISTOR	ERJ3GEYJ 333 V (33 kΩ)
R4100	7030003280	S.RESISTOR	ERJ3GEYJ 470 V (47 Ω)
R4101	7030003400	S.RESISTOR	ERJ3GEYJ 471 V (470 Ω)
R4102	7030003680	S.RESISTOR	ERJ3GEYJ 104 V (100 kΩ)
R4103	7030003800	S.RESISTOR	ERJ3GEYJ 105 V (1 MΩ)
C4001	4030007050	S.CERAMIC	C1608 CH 1H 220J-T-A
C4002	4030006980	S.CERAMIC	C1608 CH 1H 070D-T-A
C4003	4030008580	S.CERAMIC	C1608 CH 1H 300J-T-A
C4004	4030006940	S.CERAMIC	C1608 CH 1H 030C-T-A
C4005	4030007040	S.CERAMIC	C1608 CH 1H 180J-T-A
C4006	4030006860	S.CERAMIC	C1608 JB 1H 102K-T-A
C4007	4030007050	S.CERAMIC	C1608 CH 1H 220J-T-A
C4008	4030007080	S.CERAMIC	C1608 CH 1H 390J-T-A
C4009	4030007030	S.CERAMIC	C1608 CH 1H 150J-T-A
C4010	4030006860	S.CERAMIC	C1608 JB 1H 102K-T-A
C4011	4030006860	S.CERAMIC	C1608 JB 1H 102K-T-A
C4012	4030007030	S.CERAMIC	C1608 CH 1H 150J-T-A
C4013	4030007030	S.CERAMIC	C1608 CH 1H 150J-T-A
C4014	4030006860	S.CERAMIC	C1608 JB 1H 102K-T-A
C4015	4030006860	S.CERAMIC	C1608 JB 1H 102K-T-A
C4016	4030006860	S.CERAMIC	C1608 JB 1H 102K-T-A
C4017	4030006950	S.CERAMIC	C1608 CH 1H 040C-T-A
C4018	4030007110	S.CERAMIC	C1608 CH 1H 680J-T-A
C4019	4030006860	S.CERAMIC	C1608 JB 1H 102K-T-A
C4020	4030007110	S.CERAMIC	C1608 CH 1H 680J-T-A
C4023	4030006860	S.CERAMIC	C1608 JB 1H 102K-T-A
C4024	4030006860	S.CERAMIC	C1608 JB 1H 102K-T-A
C4025	4030006860	S.CERAMIC	C1608 JB 1H 102K-T-A
C4027	4030007110	S.CERAMIC	C1608 CH 1H 680J-T-A
C4028	4030006860	S.CERAMIC	C1608 JB 1H 102K-T-A
C4029	4030007110	S.CERAMIC	C1608 CH 1H 680J-T-A
C4031	4030006860	S.CERAMIC	C1608 JB 1H 102K-T-A
C4032	4030006860	S.CERAMIC	C1608 JB 1H 102K-T-A
C4033	4030007080	S.CERAMIC	C1608 CH 1H 390J-T-A
C4034	4030006860	S.CERAMIC	C1608 JB 1H 102K-T-A
C4036	4030006980	S.CERAMIC	C1608 CH 1H 070D-T-A
	4030007020	S.CERAMIC	C1608 CH 1H 120J-T-A
			[IC-A2]
			[IC-A3]
C4037	4030006900	S.CERAMIC	C1608 JB 1E 103K-T-A
C4038	4030006900	S.CERAMIC	C1608 JB 1E 103K-T-A
C4039	4030006860	S.CERAMIC	C1608 JB 1H 102K-T-A
C4040	4030006900	S.CERAMIC	C1608 JB 1E 103K-T-A
C4042	4030006860	S.CERAMIC	C1608 JB 1H 102K-T-A
C4043	4030006860	S.CERAMIC	C1608 JB 1H 102K-T-A
C4044	4030006860	S.CERAMIC	C1608 JB 1H 102K-T-A
C4045	4030007040	S.CERAMIC	C1608 CH 1H 180J-T-A
C4046	4030006860	S.CERAMIC	C1608 JB 1H 102K-T-A
C4047	4030007050	S.CERAMIC	C1608 CH 1H 220J-T-A
C4048	4030006860	S.CERAMIC	C1608 JB 1H 102K-T-A
C4049	4030006860	S.CERAMIC	C1608 JB 1H 102K-T-A
C4050	4030006860	S.CERAMIC	C1608 JB 1H 102K-T-A
C4051	4030006860	S.CERAMIC	C1608 JB 1H 102K-T-A
C4053	4030006860	S.CERAMIC	C1608 JB 1H 102K-T-A
C4054	4030006990	S.CERAMIC	C1608 CH 1H 080D-T-A
C4055	4030006860	S.CERAMIC	C1608 JB 1H 102K-T-A
C4056	4030006860	S.CERAMIC	C1608 JB 1H 102K-T-A
C4057	4030006860	S.CERAMIC	C1608 JB 1H 102K-T-A
C4058	4030006860	S.CERAMIC	C1608 JB 1H 102K-T-A
C4059	4030007080	S.CERAMIC	C1608 CH 1H 390J-T-A
C4078	4510004630	S.ELECTROLYTIC	ECEV1CA100SR

[RF UNIT]

REF. NO.	ORDER NO.	DESCRIPTION	
C4080	4510005860	S.ELECTROLYTIC	ECEV1HA2R2SR
C4090	4030006860	S.CERAMIC	C1608 JB 1H 102K-T-A
C4092	4030006860	S.CERAMIC	C1608 JB 1H 102K-T-A
C4093	4030006860	S.CERAMIC	C1608 JB 1H 102K-T-A
C4094	4510004630	S.ELECTROLYTIC	ECEV1CA100SR
C4095	4030006860	S.CERAMIC	C1608 JB 1H 102K-T-A
C4096	4030006860	S.CERAMIC	C1608 JB 1H 102K-T-A
C4097	4030006860	S.CERAMIC	C1608 JB 1H 102K-T-A
C4098	4030006860	S.CERAMIC	C1608 JB 1H 102K-T-A
C4099	4030007070	S.CERAMIC	C1608 CH 1H 330J-T-A
C4100	4030007010	S.CERAMIC	C1608 CH 1H 100D-T-A
C4101	4610001910	S.TRIMMER	CTZ3E-10A-W1
C4102	4550006150	S.TANTALUM	ECST1CY105R
C4104	4550006360	S.TANTALUM	ECST1VY104R
C4106	4030006860	S.CERAMIC	C1608 JB 1H 102K-T-A
C4107	4030006860	S.CERAMIC	C1608 JB 1H 102K-T-A
C4108	4030006860	S.CERAMIC	C1608 JB 1H 102K-T-A
C4109	4030006860	S.CERAMIC	C1608 JB 1H 102K-T-A
C4110	4030006860	S.CERAMIC	C1608 JB 1H 102K-T-A
C4111	4030006860	S.CERAMIC	C1608 JB 1H 102K-T-A
C4112	4030006860	S.CERAMIC	C1608 JB 1H 102K-T-A
C4113	4030007040	S.CERAMIC	C1608 CH 1H 180J-T-A
C4114	4030006860	S.CERAMIC	C1608 JB 1H 102K-T-A
C4115	4030006860	S.CERAMIC	C1608 JB 1H 102K-T-A
C4116	4030006860	S.CERAMIC	C1608 JB 1H 102K-T-A
C4118	4030006860	S.CERAMIC	C1608 JB 1H 102K-T-A
C4119	4030006860	S.CERAMIC	C1608 JB 1H 102K-T-A
C4121	4030006860	S.CERAMIC	C1608 JB 1H 102K-T-A
C4122	4030006860	S.CERAMIC	C1608 JB 1H 102K-T-A
C4123	4030006860	S.CERAMIC	C1608 JB 1H 102K-T-A
C4124	4030006860	S.CERAMIC	C1608 JB 1H 102K-T-A
C4125	4030006860	S.CERAMIC	C1608 JB 1H 102K-T-A
C4126	4030006860	S.CERAMIC	C1608 JB 1H 102K-T-A
C4127	4030006860	S.CERAMIC	C1608 JB 1H 102K-T-A
C4129	4030006860	S.CERAMIC	C1608 JB 1H 102K-T-A
C4130	4030006860	S.CERAMIC	C1608 JB 1H 102K-T-A
C4134	4510004440	S.ELECTROLYTIC	ECEV1HA010SR
C4135	4030006860	S.CERAMIC	C1608 JB 1H 102K-T-A
C4136	4030006860	S.CERAMIC	C1608 JB 1H 102K-T-A
C4137	4030006860	S.CERAMIC	C1608 JB 1H 102K-T-A
C4138	4030006860	S.CERAMIC	C1608 JB 1H 102K-T-A
C4139	4510004630	S.ELECTROLYTIC	ECEV1CA100SR
C4140	4030006860	S.CERAMIC	C1608 JB 1H 102K-T-A
C4141	4030006860	S.CERAMIC	C1608 JB 1H 102K-T-A
C4143	4030006860	S.CERAMIC	C1608 JB 1H 102K-T-A
C4144	4030006860	S.CERAMIC	C1608 JB 1H 102K-T-A
C4145	4030006860	S.CERAMIC	C1608 JB 1H 102K-T-A
C4146	4030006860	S.CERAMIC	C1608 JB 1H 102K-T-A
C4147	4030006860	S.CERAMIC	C1608 JB 1H 102K-T-A
C4148	4030006860	S.CERAMIC	C1608 JB 1H 102K-T-A
C4149	4030006860	S.CERAMIC	C1608 JB 1H 102K-T-A
C4150	4030006860	S.CERAMIC	C1608 JB 1H 102K-T-A
C4151	4030006860	S.CERAMIC	C1608 JB 1H 102K-T-A
C4152	4030006860	S.CERAMIC	C1608 JB 1H 102K-T-A
C4153	4030006860	S.CERAMIC	C1608 JB 1H 102K-T-A
C4155	4550006220	S.TANTALUM	TEMSVA 0J 156M-8L
C4156	4030006860	S.CERAMIC	C1608 JB 1H 102K-T-A
C4158	4030006860	S.CERAMIC	C1608 JB 1H 102K-T-A
C4159	4030009510	S.CERAMIC	C1608 CH 1H 010B-T-A
C4160	4030009520	S.CERAMIC	C1608 CH 1H 020B-T-A
C4161	4030009570	S.CERAMIC	C1608 CH 1H 0R3B-T-A
C4162	4030009510	S.CERAMIC	C1608 CH 1H 010B-T-A
C4163	4030007070	S.CERAMIC	C1608 CH 1H 330J-T-A
C4164	4030010070	S.CERAMIC	C1608 X7S 1C 104K-T-A
W4001	7030003860	S.JUMPER	ERJ3GE JPW V
W4002	7030003860	S.JUMPER	ERJ3GE JPW V
W4003	7030003860	S.JUMPER	ERJ3GE JPW V
W4004	7030003860	S.JUMPER	ERJ3GE JPW V
W4005	7030003860	S.JUMPER	ERJ3GE JPW V
W4006	7030003860	S.JUMPER	ERJ3GE JPW V
W4007	7120000380	JUMPER	JPW 01 R-01
W4011	8900005320	FFC	OPC-519
W4012	7030003860	S.JUMPER	ERJ3GE JPW V
W4013	7030003860	S.JUMPER	ERJ3GE JPW V

S.=Surface mount

[RF UNIT]

REF. NO.	ORDER NO.	DESCRIPTION	
W4015	7030003860	S.JUMPER	ERJ3GE JPW V
J4002	6450001300	CONNECTOR	HEC0779-010030
J4003	6450000130	CONNECTOR	HSJ1102-01-540
J4004	6450001060	CONNECTOR	HSJ1493-01-010
J4005	6510007090	CONNECTOR	PI28A-04M
J4006	6510017720	S.CONNECTOR	IL-FPR-30S-VF-E1500
EP4001	0910043805	PCB	B 4234E

[MAIN UNIT]

REF. NO.	ORDER NO.	DESCRIPTION	
R5001	7030003480	S.RESISTOR	ERJ3GEYJ 222 V (2.2 kΩ)
R5008	7030003680	S.RESISTOR	ERJ3GEYJ 104 V (100 kΩ)
R5009	7030003500	S.RESISTOR	ERJ3GEYJ 332 V (3.3 kΩ)
R5010	7030003520	S.RESISTOR	ERJ3GEYJ 472 V (4.7 kΩ)
R5011	7030003680	S.RESISTOR	ERJ3GEYJ 104 V (100 kΩ)
R5012	7030003500	S.RESISTOR	ERJ3GEYJ 332 V (3.3 kΩ)
R5013	7030003730	S.RESISTOR	ERJ3GEYJ 274 V (270 kΩ)
R5014	7030003520	S.RESISTOR	ERJ3GEYJ 472 V (4.7 kΩ)
R5015	7030003720	S.RESISTOR	ERJ3GEYJ 224 V (220 kΩ)
R5016	7030003680	S.RESISTOR	ERJ3GEYJ 104 V (100 kΩ)
R5017	7030003740	S.RESISTOR	ERJ3GEYJ 334 V (330 kΩ)
R5018	7030003680	S.RESISTOR	ERJ3GEYJ 104 V (100 kΩ)
R5020	7030003520	S.RESISTOR	ERJ3GEYJ 472 V (4.7 kΩ)
R5021	7030003630	S.RESISTOR	ERJ3GEYJ 393 V (39 kΩ)
R5023	7030003310	S.RESISTOR	ERJ3GEYJ 820 V (82 Ω)
R5024	7030003200	S.RESISTOR	ERJ3GEYJ 100 V (10 Ω)
R5025	7030003420	S.RESISTOR	ERJ3GEYJ 681 V (680 Ω)
R5026	7030003400	S.RESISTOR	ERJ3GEYJ 471 V (470 Ω)
R5027	7030003590	S.RESISTOR	ERJ3GEYJ 183 V (18 kΩ)
R5029	7030003680	S.RESISTOR	ERJ3GEYJ 104 V (100 kΩ)
R5030	7030003650	S.RESISTOR	ERJ3GEYJ 563 V (56 kΩ)
R5031	7030003650	S.RESISTOR	ERJ3GEYJ 563 V (56 kΩ)
R5035	7030003480	S.RESISTOR	ERJ3GEYJ 152 V (1.5 kΩ)
R5036	7030003400	S.RESISTOR	ERJ3GEYJ 471 V (470 Ω)
R5037	7030003680	S.RESISTOR	ERJ3GEYJ 104 V (100 kΩ)
R5043	7030003680	S.RESISTOR	ERJ3GEYJ 104 V (100 kΩ)
R5044	7030003540	S.RESISTOR	ERJ3GEYJ 682 V (6.8 kΩ)
R5045	7030003640	S.RESISTOR	ERJ3GEYJ 473 V (47 kΩ)
R5047	7310003610	S.TRIMMER	EVM-1XSX50 B14 (103)
R5049	7030003270	S.RESISTOR	ERJ3GEYJ 390 V (39 Ω)
R5050	7030003580	S.RESISTOR	ERJ3GEYJ 153 V (15 kΩ)
R5051	7030003800	S.RESISTOR	ERJ3GEYJ 105 V (1 MΩ)
R5052	7030003680	S.RESISTOR	ERJ3GEYJ 104 V (100 kΩ)
R5053	7030003680	S.RESISTOR	ERJ3GEYJ 104 V (100 kΩ)
R5054	7030003680	S.RESISTOR	ERJ3GEYJ 104 V (100 kΩ)
R5055	7030003680	S.RESISTOR	ERJ3GEYJ 104 V (100 kΩ)
R5058	7030003630	S.RESISTOR	ERJ3GEYJ 393 V (39 kΩ)
R5059	7030003630	S.RESISTOR	ERJ3GEYJ 393 V (39 kΩ)
R5060	7030003630	S.RESISTOR	ERJ3GEYJ 393 V (39 kΩ)
R5061	7030003400	S.RESISTOR	ERJ3GEYJ 471 V (470 Ω)
R5062	7030003580	S.RESISTOR	ERJ3GEYJ 103 V (10 kΩ)
R5063	7030003580	S.RESISTOR	ERJ3GEYJ 103 V (10 kΩ)
R5064	7030003580	S.RESISTOR	ERJ3GEYJ 103 V (10 kΩ)
R5065	7030003580	S.RESISTOR	ERJ3GEYJ 103 V (10 kΩ)
R5066	7030003580	S.RESISTOR	ERJ3GEYJ 103 V (10 kΩ)
R5070	7030003480	S.RESISTOR	ERJ3GEYJ 222 V (2.2 kΩ)
R5071	7030003480	S.RESISTOR	ERJ3GEYJ 222 V (2.2 kΩ)
R5072	7030003680	S.RESISTOR	ERJ3GEYJ 104 V (100 kΩ)
R5074	7030003650	S.RESISTOR	ERJ3GEYJ 563 V (56 kΩ)
R5075	7030003640	S.RESISTOR	ERJ3GEYJ 473 V (47 kΩ)
R5076	7030003480	S.RESISTOR	ERJ3GEYJ 222 V (2.2 kΩ)
R5077	7030003520	S.RESISTOR	ERJ3GEYJ 472 V (4.7 kΩ)
R5078	7030003630	S.RESISTOR	ERJ3GEYJ 393 V (39 kΩ)
R5082	7210002670	VARIABLE	RV-298 (TP96D00N15F10KB10KA)
R5083	7030003580	S.RESISTOR	ERJ3GEYJ 103 V (10 kΩ)
R5084	7030003440	S.RESISTOR	ERJ3GEYJ 102 V (1 kΩ)
R5085	7030003600	S.RESISTOR	ERJ3GEYJ 223 V (22 kΩ)
R5086	7030003560	S.RESISTOR	ERJ3GEYJ 103 V (10 kΩ)
R5087	4610001530	S.TRIMMER	EVM-1XSX50 B13 (102)
R5088	7030003440	S.RESISTOR	ERJ3GEYJ 102 V (1 kΩ)
R5089	7030003580	S.RESISTOR	ERJ3GEYJ 103 V (10 kΩ)
R5090	7030003440	S.RESISTOR	ERJ3GEYJ 102 V (1 kΩ)
R5091	7030003620	S.RESISTOR	ERJ3GEYJ 333 V (33 kΩ)
R5092	7030000170	S.RESISTOR	MCR10EZJH 18 Ω (180)
R5093	7030003580	S.RESISTOR	ERJ3GEYJ 103 V (10 kΩ)
R5097	7030003680	S.RESISTOR	ERJ3GEYJ 104 V (100 kΩ)
R5098	7310003660	S.TRIMMER	EVM-1XSX50 B55 (504)
R5099	7030003760	S.RESISTOR	ERJ3GEYJ 474 V (470 kΩ)
R5100	7030003760	S.RESISTOR	ERJ3GEYJ 474 V (470 kΩ)
R5101	7030003720	S.RESISTOR	ERJ3GEYJ 224 V (220 kΩ)
R5102	7030003320	S.RESISTOR	ERJ3GEYJ 101 V (100 Ω)
R5103	7030003500	S.RESISTOR	ERJ3GEYJ 332 V (3.3 kΩ)
R5104	7030003540	S.RESISTOR	ERJ3GEYJ 682 V (6.8 kΩ)
R5105	7030003700	S.RESISTOR	ERJ3GEYJ 154 V (150 kΩ)
R5106	7030003880	S.RESISTOR	ERJ3GEYJ 244 V (240 kΩ)

[MAIN UNIT]

REF. NO.	ORDER NO.	DESCRIPTION	
IC5001	1110003490	S.IC	TA31136FN(D,EL)
IC5002	1130005640	S.IC	TC4W53F (TE12L)
IC5003	1110002330	IC	TA7368P
IC5004	1110003670	S.IC	BA3308F-T1
IC5005	1130007650	S.IC	TC75W51FU (TE12L)
IC5006	1180001170	S.IC	S-81250SG-QD-T1
IC5007	1110002860	S.IC	TA75S393F (TE85R)
IC5008	1130004200	S.IC	TC4S66F (TE85R)
Q5002	1530002600	S.TRANSISTOR	2SC4215-O (TE85R)
Q5003	1530002600	S.TRANSISTOR	2SC4215-O (TE85R)
Q5004	1530003280	S.TRANSISTOR	2SC4211-6-TR
Q5005	1530003280	S.TRANSISTOR	2SC4211-6-TR
Q5006	1520000650	S.TRANSISTOR	2SB1201-S-TL
Q5007	1530003280	S.TRANSISTOR	2SC4211-6-TR
Q5008	1590001140	S.TRANSISTOR	UN9210(TX)
Q5009	1590001140	S.TRANSISTOR	UN9210(TX)
Q5010	1540000520	S.TRANSISTOR	2SD1819A(TX)R
Q5013	1590001980	S.TRANSISTOR	XP4315(TX)
Q5014	1520000460	S.TRANSISTOR	2SB1132 T100 R
Q5015	1530003280	S.TRANSISTOR	2SC4211-6-TR
Q5016	1520000460	S.TRANSISTOR	2SB1132 T100 R
Q5017	1530003280	S.TRANSISTOR	2SC4211-6-TR
Q5018	1590001130	S.TRANSISTOR	UN9110(TX)
Q5019	1520000460	S.TRANSISTOR	2SB1132 T100 R
Q5020	1530003280	S.TRANSISTOR	2SC4211-6-TR
Q5026	1530003280	S.TRANSISTOR	2SC4211-6-TR
Q5027	1510000880	S.TRANSISTOR	2SA1622-6-TR
Q5028	1520000460	S.TRANSISTOR	2SB1132 T100 R
Q5029	1590001150	S.TRANSISTOR	UN9211(TX)
Q5030	1530002600	S.TRANSISTOR	2SC4215-O (TE85R)
Q5031	1540000520	S.TRANSISTOR	2SD1819A(TX)R
D5003	1790001280	S.DIODE	MA111(TX)
D5005	1790001280	S.DIODE	MA111(TX)
D5006	1790001280	S.DIODE	MA111(TX)
D5007	1790001280	S.DIODE	MA111(TX)
D5008	1790001280	S.DIODE	MA111(TX)
D5009	1790000860	S.DIODE	MA133(TX)
D5010	1790001280	S.DIODE	MA111(TX)
D5011	1790001330	S.ZENER	MA8036-L(TX)
D5013	1790001280	S.DIODE	MA111(TX)
D5014	1790001280	S.DIODE	MA111(TX)
D5015	1790000860	S.DIODE	MA133(TX)
D5015	1790000860	S.DIODE	MA133(TX)
FI5001	2020001070	CERAMIC	CFWS455D
X5001	6050008880	XTAL	CR-458 (35.345106MHz)
X5002	6070000130	DISCRIMINATOR	CDBM455C24

S.=Surface mount

[MAIN UNIT]

REF. NO.	ORDER NO.	DESCRIPTION
R5107	7030003700	S.RESISTOR ERJ3GEYJ 154 V (150 kΩ)
R5108	7030003480	S.RESISTOR ERJ3GEYJ 152 V (1.5 kΩ)
R5112	7030003700	S.RESISTOR ERJ3GEYJ 154 V (150 kΩ)
R5113	7030003800	S.RESISTOR ERJ3GEYJ 223 V (22 kΩ)
R5114	7310003830	S.TRIMMER EVM-1XSX50 BQ4 (473)
R5115	7030003590	S.RESISTOR ERJ3GEYJ 183 V (18 kΩ)
R5116	7030003880	S.RESISTOR ERJ3GEYJ 104 V (100 kΩ)
R5117	7030003340	S.RESISTOR ERJ3GEYJ 151 V (150 Ω)
R5118	7030003780	S.RESISTOR ERJ3GEYJ 474 V (470 kΩ)
R5120	7510001000	S.THERMISTOR TBPS1R154K475H5Q
R5121	7030003780	S.RESISTOR ERJ3GEYJ 474 V (470 kΩ)
R5123	7510000990	S.THERMISTOR TBPS1R882K440H5Q
	7510000970	S.THERMISTOR TBPS1R472K440H5Q
		[IC-A2]
		[IC-A3]
R5124	7030003480	S.RESISTOR ERJ3GEYJ 152 V (1.5 kΩ)
R5125	7030003710	S.RESISTOR ERJ3GEYJ 184 V (180 kΩ)
R5126	7030003710	S.RESISTOR ERJ3GEYJ 184 V (180 kΩ)
R5127	7030003800	S.RESISTOR ERJ3GEYJ 105 V (1 MΩ)
R5128	7030003860	S.RESISTOR ERJ3GEYJ 683 V (68 kΩ)
R5129	7030003850	S.RESISTOR ERJ3GEYJ 583 V (58 kΩ)
R5130	7030003770	S.RESISTOR ERJ3GEYJ 584 V (580 kΩ)
C5001	4030006980	S.CERAMIC C1808 CH 1H 070D-T-A
C5002	4030007030	S.CERAMIC C1808 CH 1H 150J-T-A
C5003	4030010070	S.CERAMIC C1808 X7S 1C 104K-T-A
C5004	4030006900	S.CERAMIC C1808 JB 1E 103K-T-A
C5005	4030006880	S.CERAMIC C1808 JB 1H 102K-T-A
C5006	4030006900	S.CERAMIC C1808 JB 1E 103K-T-A
C5007	4030006900	S.CERAMIC C1808 JB 1E 103K-T-A
C5008	4030006900	S.CERAMIC C1808 JB 1E 103K-T-A
C5010	4030006870	S.CERAMIC C1808 JB 1H 222K-T-A
C5011	4030006900	S.CERAMIC C1808 JB 1E 103K-T-A
C5012	4030006880	S.CERAMIC C1808 JB 1H 102K-T-A
C5013	4510004440	S.ELECTROLYTIC ECEV1HA010SR
C5014	4510005810	S.ELECTROLYTIC ECEV1HAR47R
C5015	4030006850	S.CERAMIC C1808 JB 1H 471K-T-A
C5016	4510005870	S.ELECTROLYTIC ECEV1HA3R3SR
C5017	4510005320	S.ELECTROLYTIC ECEV0JA101SP
C5018	4030008920	S.CERAMIC C1808 JB 1C 473K-T-A
C5019	4030010070	S.CERAMIC C1808 X7S 1C 104K-T-A
C5020	4510005370	S.ELECTROLYTIC ECEV1AA221P
C5021	4510005860	S.ELECTROLYTIC ECEV1HA2R2SR
C5022	4030010070	S.CERAMIC C1808 X7S 1C 104K-T-A
C5024	4510005740	S.ELECTROLYTIC ECEV1HAR22SR
C5025	4510004630	S.ELECTROLYTIC ECEV1CA100SR
		[IC-A22 only]
C5026	4510005810	S.ELECTROLYTIC ECEV1HAR47R
C5030	4030007130	S.CERAMIC C1808 CH 1H 101J-T-A
C5031	4030006880	S.CERAMIC C1808 JB 1H 102K-T-A
C5032	4030006880	S.CERAMIC C1808 JB 1H 102K-T-A
C5033	4030006900	S.CERAMIC C1808 JB 1E 103K-T-A
C5034	4030006900	S.CERAMIC C1808 JB 1E 103K-T-A
C5040	4030008920	S.CERAMIC C1808 JB 1C 473K-T-A
C5041	4030010070	S.CERAMIC C1808 X7S 1C 104K-T-A
C5043	4550006220	S.TANTALUM TEMSVA 0J 156M-8L
C5045	4510005860	S.ELECTROLYTIC ECEV1HA2R2SR
C5046	4510004630	S.ELECTROLYTIC ECEV1CA100SR
C5048	4030008850	S.CERAMIC C1808 JB 1H 332K-T-A
	4030008470	S.CERAMIC C1808 JB 1H 272K-T-A
		[IC-A2]
		[IC-A3]
C5049	4030006900	S.CERAMIC C1808 JB 1E 103K-T-A
C5050	4030007160	S.CERAMIC C1808 CH 1H 181J-T-A
	4030007150	S.CERAMIC C1808 CH 1H 151J-T-A
		[IC-A2]
		[IC-A3]
C5051	4550006150	S.TANTALUM ECST1CY105R
C5052	4510005830	S.ELECTROLYTIC ECEV1EA330SP
C5053	4030006880	S.CERAMIC C1808 JB 1H 102K-T-A
C5054	4030006880	S.CERAMIC C1808 JB 1H 102K-T-A
C5055	4510005430	S.ELECTROLYTIC ECEV0JA220SR
C5056	4510005430	S.ELECTROLYTIC ECEV0JA220SR
C5057	4510005430	S.ELECTROLYTIC ECEV0JA220SR
C5058	4510005430	S.ELECTROLYTIC ECEV0JA220SR

[MAIN UNIT]

REF. NO.	ORDER NO.	DESCRIPTION
C5059	4510005430	S.ELECTROLYTIC ECEV0JA220SR
C5060	4030006900	S.CERAMIC C1808 JB 1E 103K-T-A
C5062	4510004630	S.ELECTROLYTIC ECEV1CA100SR
C5063	4030006900	S.CERAMIC C1808 JB 1E 103K-T-A
C5064	4030006880	S.CERAMIC C1808 JB 1H 102K-T-A
C5065	4030010070	S.CERAMIC C1808 X7S 1C 104K-T-A
C5066	4030006900	S.CERAMIC C1808 JB 1E 103K-T-A
C5067	4030006900	S.CERAMIC C1808 JB 1E 103K-T-A
C5068	4030006880	S.CERAMIC C1808 JB 1H 102K-T-A
C5069	4030006880	S.CERAMIC C1808 JB 1H 102K-T-A
C5070	4030006880	S.CERAMIC C1808 JB 1H 102K-T-A
C5071	4030006880	S.CERAMIC C1808 JB 1H 102K-T-A
C5072	4550006370	S.TANTALUM ECST0JX226R
C5073	4030006880	S.CERAMIC C1808 JB 1H 102K-T-A
C5074	4030006880	S.CERAMIC C1808 JB 1H 102K-T-A
C5075	4030010070	S.CERAMIC C1808 X7S 1C 104K-T-A
C5076	4030006880	S.CERAMIC C1808 JB 1H 472K-T-A
C5077	4510004630	S.ELECTROLYTIC ECEV1CA100SR
C5078	4030010070	S.CERAMIC C1808 X7S 1C 104K-T-A
C5079	4030006850	S.CERAMIC C1808 JB 1H 471K-T-A
C5080	4030010070	S.CERAMIC C1808 X7S 1C 104K-T-A
C5081	4030006900	S.CERAMIC C1808 JB 1E 103K-T-A
C5082	4550006220	S.TANTALUM TEMSVA 0J 156M-8L
C5083	4550006360	S.TANTALUM ECST1VY104R
C5084	4030010070	S.CERAMIC C1808 X7S 1C 104K-T-A
C5085	4510005820	S.ELECTROLYTIC ECEV1CA101P
C5086	4510004440	S.ELECTROLYTIC ECEV1HA010SR
C5088	4030006880	S.CERAMIC C1808 JB 1H 102K-T-A
C5089	4030006880	S.CERAMIC C1808 JB 1H 102K-T-A
C5090	4510004650	S.ELECTROLYTIC ECEV1EA4R7SR
W5002	7030003860	S.JUMPER ERJ3GE JPW V
W5008	7030003860	S.JUMPER ERJ3GE JPW V
J5001	6510017700	S.CONNECTOR IL-WX-18PB-VF84-B-E900
J5002	6510017700	S.CONNECTOR IL-WX-18PB-VF84-B-E900
J5003	6510017730	S.CONNECTOR IL-FPR-30S-HF-E3000
J5005	6510007080	CONNECTOR PI28A-02M
S5001	2250000240	SWITCH SW-157 (RH09710HH)
EP5002	0910043815	PCB B 4235E

S.=Surface mount

[LOGIC UNIT] for IC-A22/A22E

REF. NO.	ORDER NO.	DESCRIPTION	
IC6001	1140004880	S.IC	HD40482B96TF
IC6002	1190000280	S.IC	24LC08BT1/SN
IC6003	1130007340	S.IC	S-80745SL-A9-T1
IC6004	1130003920	S.IC	TC4S69F (TE85R)
IC6105	1110003780	S.IC	NJM2902V-TE1
IC6106	1110003790	S.IC	NJM2903V-TE1
IC6107	1110003800	S.IC	NJM2904V-TE1
IC6108	1110003790	S.IC	NJM2903V-TE1
Q6001	1590001840	S.TRANSISTOR	XN4601(TX)
Q6002	1530003280	S.TRANSISTOR	2SC4211-8-TR
Q6003	1530003280	S.TRANSISTOR	2SC4211-8-TR
Q6004	1520000460	S.TRANSISTOR	2SB1132 T100 R
Q6005	1530003280	S.TRANSISTOR	2SC4211-8-TR
Q6006	1590001150	S.TRANSISTOR	UN9211(TX)
Q6007	1510000880	S.TRANSISTOR	2SA1622-8-TR
Q6108	1590001980	S.TRANSISTOR	XP4315(TX)
Q6109	1530003280	S.TRANSISTOR	2SC4211-8-TR
Q6110	1590001470	S.TRANSISTOR	UN9213(TX)
D6001	1790001280	S.DIODE	MA111(TX)
D6002	1790001280	S.DIODE	MA111(TX)
D6003	1790001280	S.DIODE	MA111(TX)
D6004	1790001280	S.DIODE	MA111(TX)
D6005	1790001200	S.DIODE	MA6S121(TX)
D6008	1790000810	S.DIODE	MA132A(TX)
D6009	1160000050	S.DIODE	DAP202U T107 [IC-A22E] only
D6014	1790000990	S.ZENER	MA8051-H(TX)
D6115	1790001280	S.DIODE	MA111(TX)
D6116	1790001280	S.DIODE	MA111(TX)
MC6001	7700001520	MICROPHONE	EM-123T
X6001	6050007390	XTAL	CR-331
R6001	7030003640	S.RESISTOR	ERJ3GEYJ 473 V (47 kΩ)
R6002	7030003680	S.RESISTOR	ERJ3GEYJ 104 V (100 kΩ)
R6003	7030003590	S.RESISTOR	ERJ3GEYJ 183 V (18 kΩ)
R6004	7030003630	S.RESISTOR	ERJ3GEYJ 393 V (39 kΩ)
R6005	7030003740	S.RESISTOR	ERJ3GEYJ 334 V (330 kΩ)
R6006	7030004870	S.RESISTOR	ERJ3GEYF 224 V (220 kΩ)
R6007	7030004810	S.RESISTOR	ERJ3GEYF 433 V (43 kΩ)
R6008	7030003480	S.RESISTOR	ERJ3GEYJ 222 V (2.2 kΩ)
R6009	7030003510	S.RESISTOR	ERJ3GEYJ 392 V (3.9 kΩ)
R6010	7030003430	S.RESISTOR	ERJ3GEYJ 821 V (820 Ω)
R6011	7030003430	S.RESISTOR	ERJ3GEYJ 821 V (820 Ω)
R6012	7030003380	S.RESISTOR	ERJ3GEYJ 331 V (330 Ω)
R6013	7030003640	S.RESISTOR	ERJ3GEYJ 473 V (47 kΩ)
R6016	7030003560	S.RESISTOR	ERJ3GEYJ 103 V (10 kΩ)
R6017	7030003640	S.RESISTOR	ERJ3GEYJ 473 V (47 kΩ)
R6018	7030003540	S.RESISTOR	ERJ3GEYJ 682 V (6.8 kΩ)
R6019	7030003620	S.RESISTOR	ERJ3GEYJ 333 V (33 kΩ)
R6020	7030003590	S.RESISTOR	ERJ3GEYJ 183 V (18 kΩ)
R6021	7030003620	S.RESISTOR	ERJ3GEYJ 333 V (33 kΩ)
R6022	7030003800	S.RESISTOR	ERJ3GEYJ 105 V (1 MΩ)
R6023	7030003680	S.RESISTOR	ERJ3GEYJ 104 V (100 kΩ)
R6024	7030003800	S.RESISTOR	ERJ3GEYJ 105 V (1 MΩ)
R6025	7410000590	S.ARRAY	EXB-V4V 473JV (47 kΩ)
R6026	7030003240	S.RESISTOR	ERJ3GEYJ 220 V (22 Ω)
R6027	7030003590	S.RESISTOR	ERJ3GEYJ 183 V (18 kΩ)
R6101	7030003720	S.RESISTOR	ERJ3GEYJ 224 V (220 kΩ)
R6125	7030003650	S.RESISTOR	ERJ3GEYJ 583 V (58 kΩ)
R6126	7030003620	S.RESISTOR	ERJ3GEYJ 333 V (33 kΩ)
R6127	7030003720	S.RESISTOR	ERJ3GEYJ 224 V (220 kΩ)
R6128	7030003540	S.RESISTOR	ERJ3GEYJ 682 V (6.8 kΩ)
R6129	7030003700	S.RESISTOR	ERJ3GEYJ 154 V (150 kΩ)
R6130	7030003470	S.RESISTOR	ERJ3GEYJ 182 V (1.8 kΩ)
R6131	7030003630	S.RESISTOR	ERJ3GEYJ 393 V (39 kΩ)
R6132	7030003640	S.RESISTOR	ERJ3GEYJ 473 V (47 kΩ)
R6133	7030003720	S.RESISTOR	ERJ3GEYJ 224 V (220 kΩ)
R6134	7030003630	S.RESISTOR	ERJ3GEYJ 393 V (39 kΩ)
R6135	7310003630	S.TRIMMER	EVM-1XSX50 BQ4 (473)

[LOGIC UNIT] for IC-A22/A22E

REF. NO.	ORDER NO.	DESCRIPTION	
R6136	7030003750	S.RESISTOR	ERJ3GEYJ 394 V (390 kΩ)
R6137	7030003740	S.RESISTOR	ERJ3GEYJ 334 V (330 kΩ)
R6138	7030003640	S.RESISTOR	ERJ3GEYJ 473 V (47 kΩ)
R6139	7030003590	S.RESISTOR	ERJ3GEYJ 183 V (18 kΩ)
R6140	7030003520	S.RESISTOR	ERJ3GEYJ 472 V (4.7 kΩ)
R6141	7510000980	S.THERMISTOR	TBPS1R333K460H5Q
R6142	7030003620	S.RESISTOR	ERJ3GEYJ 333 V (33 kΩ)
R6143	7030003720	S.RESISTOR	ERJ3GEYJ 224 V (220 kΩ)
R6144	7030003580	S.RESISTOR	ERJ3GEYJ 153 V (15 kΩ)
R6145	7030003720	S.RESISTOR	ERJ3GEYJ 224 V (220 kΩ)
R6146	7030003720	S.RESISTOR	ERJ3GEYJ 224 V (220 kΩ)
R6147	7030003590	S.RESISTOR	ERJ3GEYJ 183 V (18 kΩ)
R6148	7030003710	S.RESISTOR	ERJ3GEYJ 184 V (180 kΩ)
R6149	7030003590	S.RESISTOR	ERJ3GEYJ 183 V (18 kΩ)
R6150	7310003590	S.TRIMMER	EVM-1XSX50 B24 (203)
R6151	7310003660	S.TRIMMER	EVM-1XSX50 B55 (504)
R6153	7030003680	S.RESISTOR	ERJ3GEYJ 104 V (100 kΩ)
R6154	7030003680	S.RESISTOR	XP4315(TX)
R6155	7030003640	S.RESISTOR	ERJ3GEYJ 473 V (47 kΩ)
R6156	7030003400	S.RESISTOR	ERJ3GEYJ 471 V (470 Ω)
R6159	7030003520	S.RESISTOR	ERJ3GEYJ 472 V (4.7 kΩ)
R6160	7030003520	S.RESISTOR	ERJ3GEYJ 472 V (4.7 kΩ)
R6161	7030003520	S.RESISTOR	ERJ3GEYJ 472 V (4.7 kΩ)
R6162	7030003520	S.RESISTOR	ERJ3GEYJ 472 V (4.7 kΩ)
R6163	7030003520	S.RESISTOR	ERJ3GEYJ 472 V (4.7 kΩ)
R6164	7030003520	S.RESISTOR	ERJ3GEYJ 472 V (4.7 kΩ)
C6001	4550006370	S.TANTALUM	ECST0JX226R
C6002	4550006530	S.TANTALUM	ECST0JY685R
C6003	4030007030	S.CERAMIC	C1608 CH 1H 150J-T-A
C6004	4030007030	S.CERAMIC	C1608 CH 1H 150J-T-A
C6005	4030010070	S.CERAMIC	C1608 X7S 1C 104K-T-A
C6006	4030010070	S.CERAMIC	C1608 X7S 1C 104K-T-A
C6007	4030010070	S.CERAMIC	C1608 X7S 1C 104K-T-A
C6008	4030010070	S.CERAMIC	C1608 X7S 1C 104K-T-A
C6009	4030008900	S.CERAMIC	C1608 JB 1E 103K-T-A
C6011	4030006860	S.CERAMIC	C1608 JB 1H 102K-T-A
C6012	4550006200	S.TANTALUM	ECST0JY106R
C6013	4550006150	S.TANTALUM	ECST1CY105R
C6014	4550006200	S.TANTALUM	ECST0JY106R
C6015	4030010070	S.CERAMIC	C1608 X7S 1C 104K-T-A
C6016	4030006860	S.CERAMIC	C1608 JB 1H 102K-T-A
C6017	4030006860	S.CERAMIC	C1608 JB 1H 102K-T-A
C6018	4550006360	S.TANTALUM	ECST1VY104R
C6019	4030006900	S.CERAMIC	C1608 JB 1E 103K-T-A
C6020	4030010070	S.CERAMIC	C1608 X7S 1C 104K-T-A
C6021	4550006340	S.TANTALUM	ECST1AY335R
C6022	4550006360	S.TANTALUM	ECST1VY104R
C6023	4550006360	S.TANTALUM	ECST1VY104R
C6024	4030006850	S.CERAMIC	C1608 JB 1H 471K-T-A
C6025	4550006360	S.TANTALUM	ECST1VY104R
C6026	4550006360	S.TANTALUM	ECST1VY104R
C6028	4550006360	S.TANTALUM	ECST1VY104R
C6029	4030006880	S.CERAMIC	C1608 JB 1H 472K-T-A
C6130	4550006370	S.TANTALUM	ECST0JX226R
C6131	4550006200	S.TANTALUM	ECST0JY106R
DS6001	5030001220	LCD	LD-BU4240J
DS6002	5010000120	S.LED	LN1371G-(TR)
DS6003	5010000120	S.LED	LN1371G-(TR)
DS6004	5010000120	S.LED	LN1371G-(TR)
DS6005	5010000120	S.LED	LN1371G-(TR)
DS6006	5040001920	S.LED	SML-110MT T86
DS6007	5040001920	S.LED	SML-110MT T86
W6101	7030003860	S.JUMPER	ERJ3GE JPW V
J6001	6510017710	S.Connector	IL-WX-18SB-VF-H4.75-B-E800
J6002	6510017710	S.Connector	IL-WX-18SB-VF-H4.75-B-E800
J6003	6510017900	Connector	3-174642-6
EP6001	0910044543	PCB	B 4437C
EP6002	8930034040	LCD CONTACT	SRCN-1541 SG

S.=Surface mount

[LOGIC UNIT] for IC-A3/A3E

REF. NO.	ORDER NO.	DESCRIPTION	
IC6001	1140004860	S.IC	HD404829B96TF
IC6002	1190000260	S.IC	24LC08BTI/SN
IC6003	1130007340	S.IC	S-80745SL-A9-T1
IC6004	1130003920	S.IC	TC4S69F (TE85R)
Q6001	1590001840	S.TRANSISTOR	XN4601(TX)
Q6002	1530003280	S.TRANSISTOR	2SC4211-6-TR
Q6003	1530003280	S.TRANSISTOR	2SC4211-6-TR
Q6004	1520000460	S.TRANSISTOR	2SB1132 T100 R
Q6005	1530003280	S.TRANSISTOR	2SC4211-6-TR
Q6006	1590001150	S.TRANSISTOR	UN9211(TX)
Q6007	1510000880	S.TRANSISTOR	2SA1622-6-TR
D6001	1790001280	S.DIODE	MA111(TX)
D6002	1790001280	S.DIODE	MA111(TX)
D6003	1790001280	S.DIODE	MA111(TX)
D6004	1790001280	S.DIODE	MA111(TX)
D6005	1790001200	S.DIODE	MA6S121(TX)
D6008	1790000840	S.DIODE	MA132WA(TX)
D6009	1790000840	S.DIODE	MA132WA(TX)
			[IC-A3E only]
D6010	1790000840	S.DIODE	MA132WA(TX)
D6014	1790000990	S.ZENER	MA8051-H(TX)
MC6001	7700001520	MICROPHONE	EM-123T
X6001	6050007390	XTAL	CR-331
R6001	7030003640	S.RESISTOR	ERJ3GEYJ 473 V (47 kΩ)
R6002	7030003680	S.RESISTOR	ERJ3GEYJ 104 V (100 kΩ)
R6003	7030003590	S.RESISTOR	ERJ3GEYJ 183 V (18 kΩ)
R6004	7030003630	S.RESISTOR	ERJ3GEYJ 393 V (39 kΩ)
R6005	7030003740	S.RESISTOR	ERJ3GEYJ 334 V (330 kΩ)
R6006	7030004870	S.RESISTOR	ERJ3GEYF 224 V (220 kΩ)
R6007	7030004810	S.RESISTOR	ERJ3GEYF 433 V (43 kΩ)
R6008	7030003480	S.RESISTOR	ERJ3GEYJ 222 V (2.2 kΩ)
R6009	7030003510	S.RESISTOR	ERJ3GEYJ 392 V (3.9 kΩ)
R6010	7030003430	S.RESISTOR	ERJ3GEYJ 821 V (820 Ω)
R6011	7030003430	S.RESISTOR	ERJ3GEYJ 821 V (820 Ω)
R6012	7030003380	S.RESISTOR	ERJ3GEYJ 331 V (330 Ω)
R6013	7030003640	S.RESISTOR	ERJ3GEYJ 473 V (47 kΩ)
R6016	7030003580	S.RESISTOR	ERJ3GEYJ 103 V (10 kΩ)
R6017	7030003640	S.RESISTOR	ERJ3GEYJ 473 V (47 kΩ)
R6018	7030003540	S.RESISTOR	ERJ3GEYJ 682 V (6.8 kΩ)
R6019	7030003620	S.RESISTOR	ERJ3GEYJ 333 V (33 kΩ)
R6020	7030003590	S.RESISTOR	ERJ3GEYJ 183 V (18 kΩ)
R6021	7030003620	S.RESISTOR	ERJ3GEYJ 333 V (33 kΩ)
R6022	7030003800	S.RESISTOR	ERJ3GEYJ 105 V (1 MΩ)
R6023	7030003680	S.RESISTOR	ERJ3GEYJ 104 V (100 kΩ)
R6024	7030003800	S.RESISTOR	ERJ3GEYJ 105 V (1 MΩ)
R6025	7410000590	S.ARRAY	EXB-V4V 473JV (47 kΩ)
R6026	7030003240	S.RESISTOR	ERJ3GEYJ 220 V (22 kΩ)
R6027	7030003590	S.RESISTOR	ERJ3GEYJ 183 V (18 kΩ)
C6001	4550008370	S.TANTALUM	ECST0JX226R
C6002	4550008530	S.TANTALUM	ECST0JY685R
C6003	4030007030	S.CERAMIC	C1608 CH 1H 150J-T-A
C6004	4030007030	S.CERAMIC	C1608 CH 1H 150J-T-A
C6005	4030010070	S.CERAMIC	C1608 X7S 1C 104K-T-A
C6006	4030010070	S.CERAMIC	C1608 X7S 1C 104K-T-A
C6007	4030010070	S.CERAMIC	C1608 X7S 1C 104K-T-A
C6008	4030010070	S.CERAMIC	C1608 X7S 1C 104K-T-A
C6009	4030006900	S.CERAMIC	C1608 JB 1E 103K-T-A
C6011	4030006860	S.CERAMIC	C1608 JB 1H 102K-T-A
DS6001	5030001180	LCD	LD-BU4278J (E-4148)
DS6002	5010000120	S.LED	LN1371G-(TR)
DS6003	5010000120	S.LED	LN1371G-(TR)
DS6004	5010000120	S.LED	LN1371G-(TR)
DS6005	5010000120	S.LED	LN1371G-(TR)
DS6006	5040001920	S.LED	SML-110MT T86
DS6007	5040001920	S.LED	SML-110MT T86
J6001	6510017710	S.Connector	IL-WX-18SB-VF-H4.75-B-E800
J6002	6510017710	S.Connector	IL-WX-18SB-VF-H4.75-B-E800

[LOGIC UNIT] for IC-A3/A3E

REF. NO.	ORDER NO.	DESCRIPTION	
J6003	6510017900	CONNECTOR	3-174642-6
EP6001	0910043823	PCB	B 4236C
EP6002	8930034040	LCD CONTACT	SRCN-1541 SG

[VCO UNIT]

REF. NO.	ORDER NO.	DESCRIPTION	
Q7001	1530002920	S.TRANSISTOR	2SC4226-T2 R25
Q7002	1530002920	S.TRANSISTOR	2SC4226-T2 R25
Q7003	1530002560	S.TRANSISTOR	2SC4403-3-TR
D7001	1790001290	S.VARICAP	MA304(TX)
D7002	1790000620	S.DIODE	MA77(TW)
L7001	6200001520	S.COIL	MLF2012D R82K-T
L7002	6110002990	COIL	LA-487
L7003	6200001630	S.COIL	ELJNC R10K-F
R7001	7030003550	S.RESISTOR	ERJ3GEYJ 822 V (8.2 kΩ)
R7002	7030003380	S.RESISTOR	ERJ3GEYJ 221 V (220 Ω)
R7003	7030003550	S.RESISTOR	ERJ3GEYJ 822 V (8.2 kΩ)
R7004	7030003380	S.RESISTOR	ERJ3GEYJ 221 V (220 Ω)
R7005	7030003320	S.RESISTOR	ERJ3GEYJ 101 V (100 Ω)
R7006	7030003610	S.RESISTOR	ERJ3GEYJ 273 V (27 kΩ)
R7007	7030003320	S.RESISTOR	ERJ3GEYJ 101 V (100 Ω)
R7008	7030003720	S.RESISTOR	ERJ3GEYJ 224 V (220 kΩ)
R7009	7030003580	S.RESISTOR	ERJ3GEYJ 103 V (10 kΩ)
C7001	4030008860	S.CERAMIC	C1608 JB 1H 102K-T-A
C7002	4030009850	S.CERAMIC	C1608 CH 1H 240J-T-A
C7004	4030009540	S.CERAMIC	C1608 CH 1H 1R5B-T-A
C7005	4030009540	S.CERAMIC	C1608 CH 1H 1R5B-T-A
C7006	4030008860	S.CERAMIC	C1608 JB 1H 102K-T-A
C7007	4030008860	S.CERAMIC	C1608 JB 1H 102K-T-A
C7008	4030009500	S.CERAMIC	C1608 CH 1H 0R5B-T-A
C7009	4030007040	S.CERAMIC	C1608 CH 1H 180J-T-A
C7010	4030008860	S.CERAMIC	C1608 JB 1H 102K-T-A
C7011	4030008860	S.CERAMIC	C1608 JB 1H 102K-T-A
C7012	4030008860	S.CERAMIC	C1608 JB 1H 102K-T-A
C7013	4030008860	S.CERAMIC	C1608 JB 1H 102K-T-A
C7014	4030008860	S.CERAMIC	C1608 JB 1H 102K-T-A
J7001	6910008020	CONNECTOR	IPS-1323
J7002	6910008020	CONNECTOR	IPS-1323
J7003	6910008020	CONNECTOR	IPS-1323
J7004	6910008020	CONNECTOR	IPS-1323
EP7001	0910044552	PCB	B 4486B

[PTT UNIT]

REF. NO.	ORDER NO.	DESCRIPTION	
J9001	6510018110	S.CONNECTOR	3-175637-6
S9001	2280002160	S.SWITCH	EVQ-PLM A15
S9002	2280001680	S.SWITCH	SKQDPB
S9003	2280001680	S.SWITCH	SKQDPB
EP9001	0910044781	PCB	B 4239A

S.=Surface mount

SECTION 6 MECHANICAL PARTS AND DISASSEMBLY

[CHASSIS PARTS]

REF. NO.	ORDER NO.	DESCRIPTION	QTY.
J3001	6510015550	Antenna Connector BNC-R117 (incl. nut)	1
MP3001	8210011440	1541 rear panel	1
MP3002	8210012230	1541 front panel (B) for IC-A22	1
	8210012240	1541 front panel (C) for IC-A22E	1
	8210011990	1541 front panel for IC-A3	1
	8210012000	1541 front panel (A) for IC-A3E	1
MP3003	8010015670	1541 chassis	1
MP3004	8930033430	1541 10-key	1
MP3005	8930033420	1541 contact base	1
MP3006	8930033510	1541 PTT rubber	1
MP3007	8930031510	1389 module shield	1
MP3008	8510009290	1541 module cover	1
MP3011	8930029121	1257 release button (A) -1	1
MP3012	8930030041	1452 contact spring -1	3
MP3013	8930029830	1452 SP rubber	1
MP3014	8310034120	1541 bottom plate	1
MP3015	8930033400	1541 DC cap	1
MP3016	8930033340	1541 SP holder	1
MP3019	8930033530	1541 DC sheet	1
MP3020	8810008480	Screw PH BT M2×29 ZK	4
MP3021	8810006610	Screw PH No. 0 M2×2.5 NI	4
MP3022	8810006610	Screw PH No. 0 M2×2.5 NI	4
MP3023	8810006610	Screw PH No. 0 M2×2.5 NI	1
MP3024	8810008350	Screw PH No. 0 M2×6 NI	3
MP3025	8810005360	Screw PH No. 0 M2×3 ZK	1
MP3026	8810008360	Screw PH No. 0 M2.6×3.5 NI	2
MP3027	8010014982	Hole bush (B) -2	2
MP3029	8930033410	1541 MIC cap	1
MP3030	8810006610	Screw PH No. 0 M2×2.5 NI	1
MP3032	8860000840	1266 lug	1
SP3001	2510000730	Speaker EAS-3P127G	1

[RF UNIT]

REF. NO.	ORDER NO.	DESCRIPTION	QTY.
MP4001	8510002640	RF-can (1) (Coil shield)	1
MP4002	8510002640	RF-can (1) (Coil shield)	1
MP4003	8930004081	Ground spring (B) -1	1
MP4004	8930004081	Ground spring (B) -1	1
MP4005	8930004081	Ground spring (B) -1	1
MP4006	8950000430	Filament tape 9510 W=12 mm, L=20 mm	1
W4011	8900005320	Flat cable OPC-519	1

[VCO BOARD]

REF. NO.	ORDER NO.	DESCRIPTION	QTY.
MP7001	8510009630	1551 VCO case	1

[MAIN UNIT]

REF. NO.	ORDER NO.	DESCRIPTION	QTY.
MP5001	8210011570	1541 top panel	1
MP5002	8610009320	Knob N-224 base	1
MP5003	8010013100	Knob N-194 cover	1
MP5004	8610009590	Knob N-195 base (A)	1
MP5005	8010013110	Knob N-195 cover	1
MP5006	8610009600	Knob N-196 base (A)	1
MP5007	8010013120	Knob N-196 cover	1
MP5008	8930033720	1541 top seal	1
MP5009	8830000790	VR nut (H)	2

[LOGIC UNIT]

REF. NO.	ORDER NO.	DESCRIPTION	QTY.
DS6001	5030001220	LCD LD-BU4240J for IC-A22/E	1
	5030001180	LCD LD-BU4279J for IC-A3/E	1
EP6002	8930034040	LCD contact SRCN-1541-SG for IC-A22/E	2
	8930034040	LCD contact SRCN-1541-SG for IC-A3/E	1
MP6002	8930033350	1541 LCD holder	1
MP6003	8210011431	1541 reflector -1	1

[PRT UNIT]

REF. NO.	ORDER NO.	DESCRIPTION	QTY.
MP8002	8860000010	Screw lug M2	3

[UNPACKING]

REF. NO.	ORDER NO.	DESCRIPTION	QTY.
EP1001	3310001480	Antenna FA-B01AR	1
EP1003	Optional product	Wall charger BM-95V [AUS]	1
	Optional product	Wall charger BM-112E [EUR]	1
	Optional product	Wall charger BM-112U [USA]	1
EP1004	Optional product	Carrying case LC-122 (IC-A22 only)	1
MP1001	8010005710	Belt clip	1
MP1002	8810005730	Screw BuH M3×3 ZK BS	2
MP1003	8310025060	1144 caution label (C)	1
W1001	8900005270	Charger adapter cable OPC-507 [AUS]	1
W1002	Optional product	Headset adapter cable OPC-499 (not included with some versions)	1



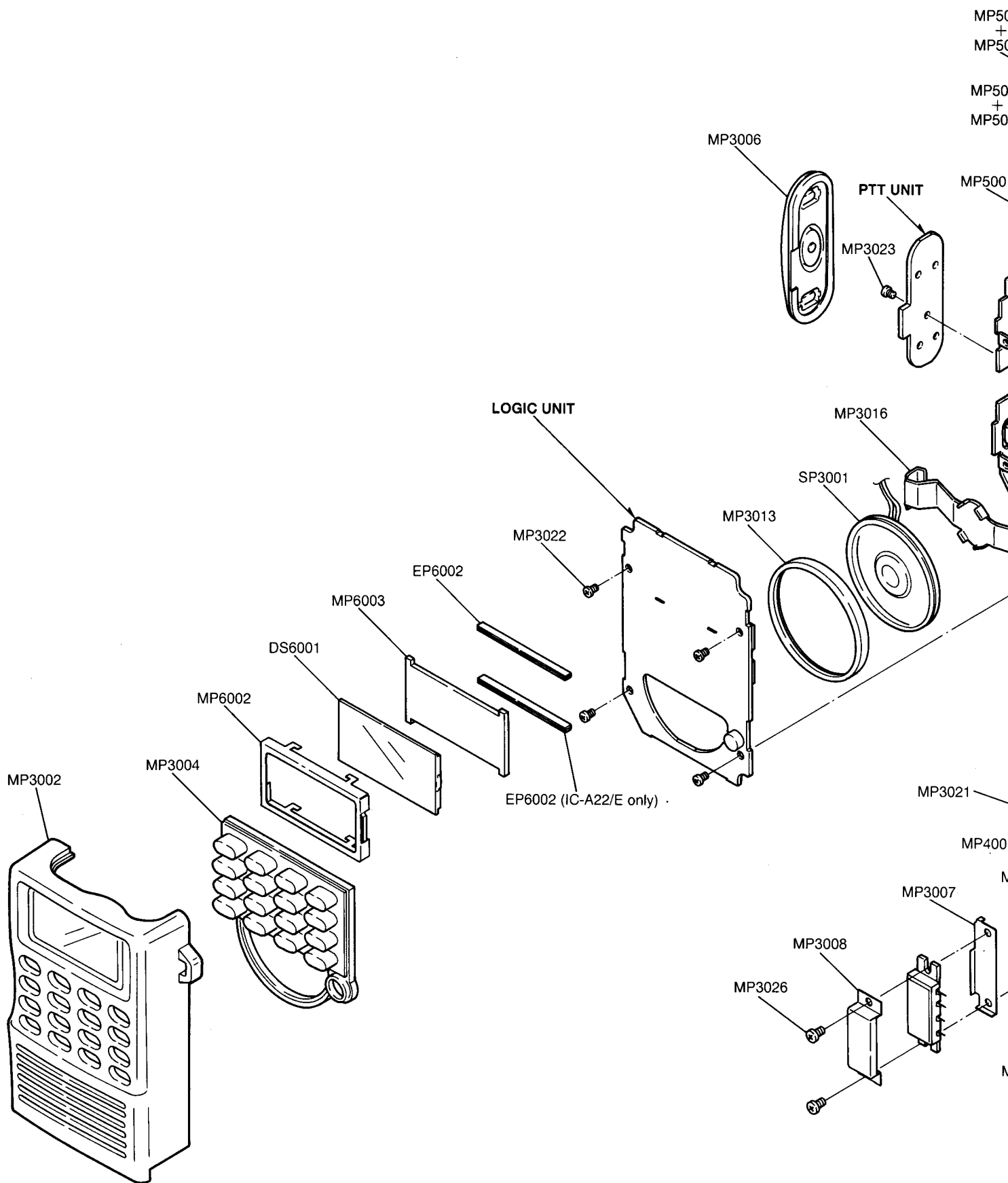

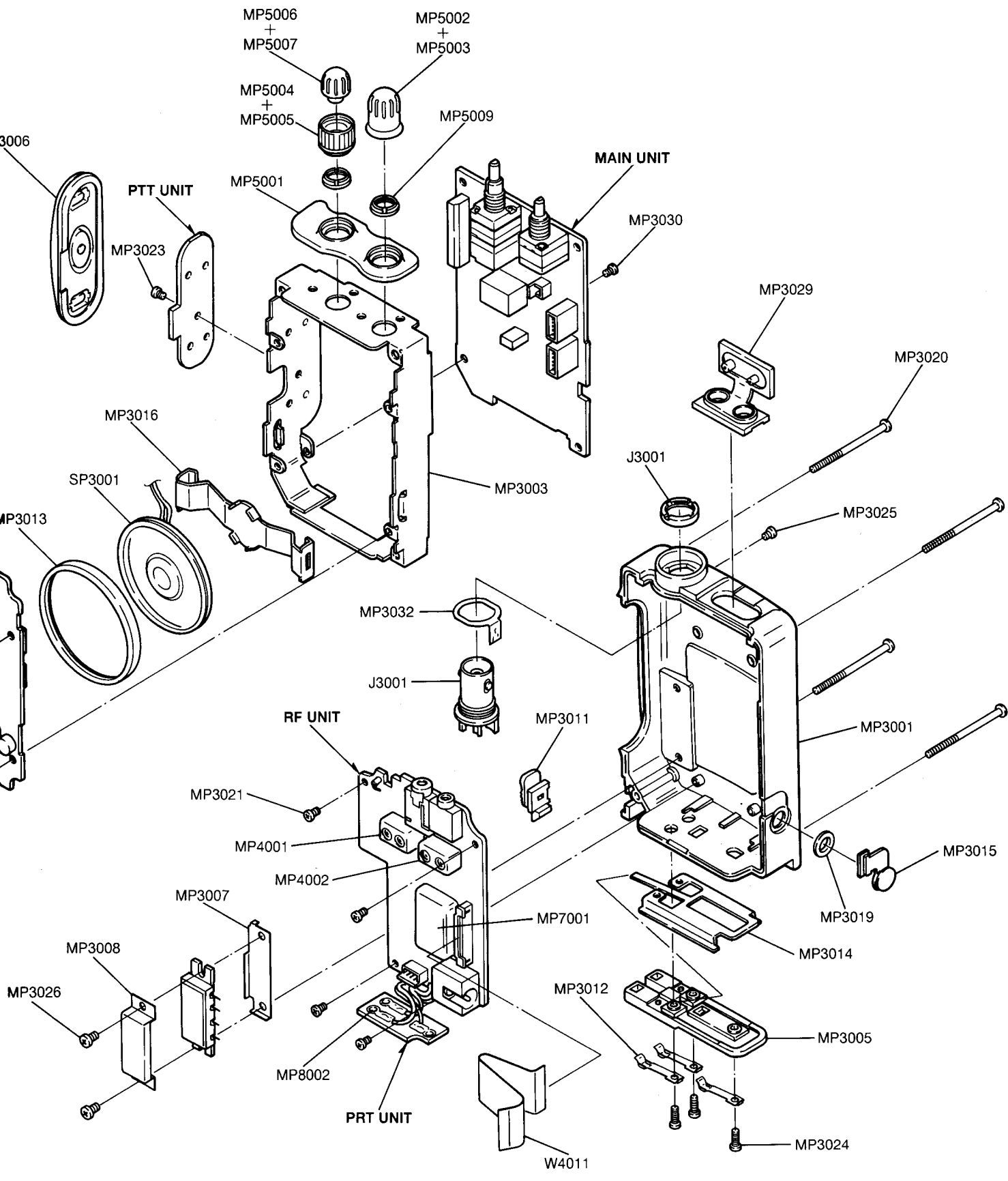







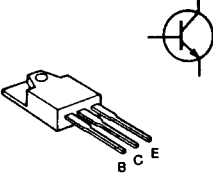



Screw abbreviations BT: Self-tapping PH: Pan head
 BuH: Button head NI: Nickel BS: Brass
 ZK: Black

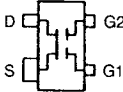
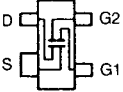











SECTION 8 SEMI-CONDUCTOR INFORMATION

• TRANSISTORS AND FET'S

<p>2SA1162 6 (Symbol: M6)</p> 	<p>2SB1132 R (Symbol: BARB)</p> 	<p>2SC3357 RF (Symbol: RF)</p> 	<p>2SC4116 BL (Symbol: LL)</p> 	<p>2SC4215 O (Symbol: QO)</p> 
<p>2SC4226 R25 (Symbol: R25)</p> 	<p>2SC4403 3 (Symbol: LY3)</p> 	<p>2SD1819A R (Symbol: LG)</p> 	<p>3SK151 Y (Symbol: UH)</p> 	<p>3SK230 U1B (Symbol: U1B)</p> 
<p>UN9110 (Symbol: 6L)</p> 	<p>UN9210 (Symbol: 8L)</p> 	<p>UN9211 (Symbol: 8A)</p> 	<p>UN9213 (Symbol: 8C)</p> 	<p>XN4601 (Symbol: 5C)</p> 
<p>XP1401 (Symbol: 5V)</p> 	<p>XP4315 (Symbol: CB)</p> 	<p>XP4601 (Symbol: 5C)</p> 		

• DIODES

<p>1SV246 TR (Symbol: CV)</p> 	<p>DAP202U (Symbol: P)</p> 	<p>MA132A (Symbol: MB)</p> 	<p>MA132WA (Symbol: MO)</p> 	<p>MA132WK (Symbol: MU)</p> 
<p>MA133 (Symbol: MP)</p> 	<p>MA6S121 (Symbol: M2D)</p> 	<p>SB30 03P TD (Symbol: SG)</p> 		

SECTION 9 BOARD LAYOUTS

9-1 PTT UNIT, VCO BOARD AND PRT UNIT

● PTT UNIT

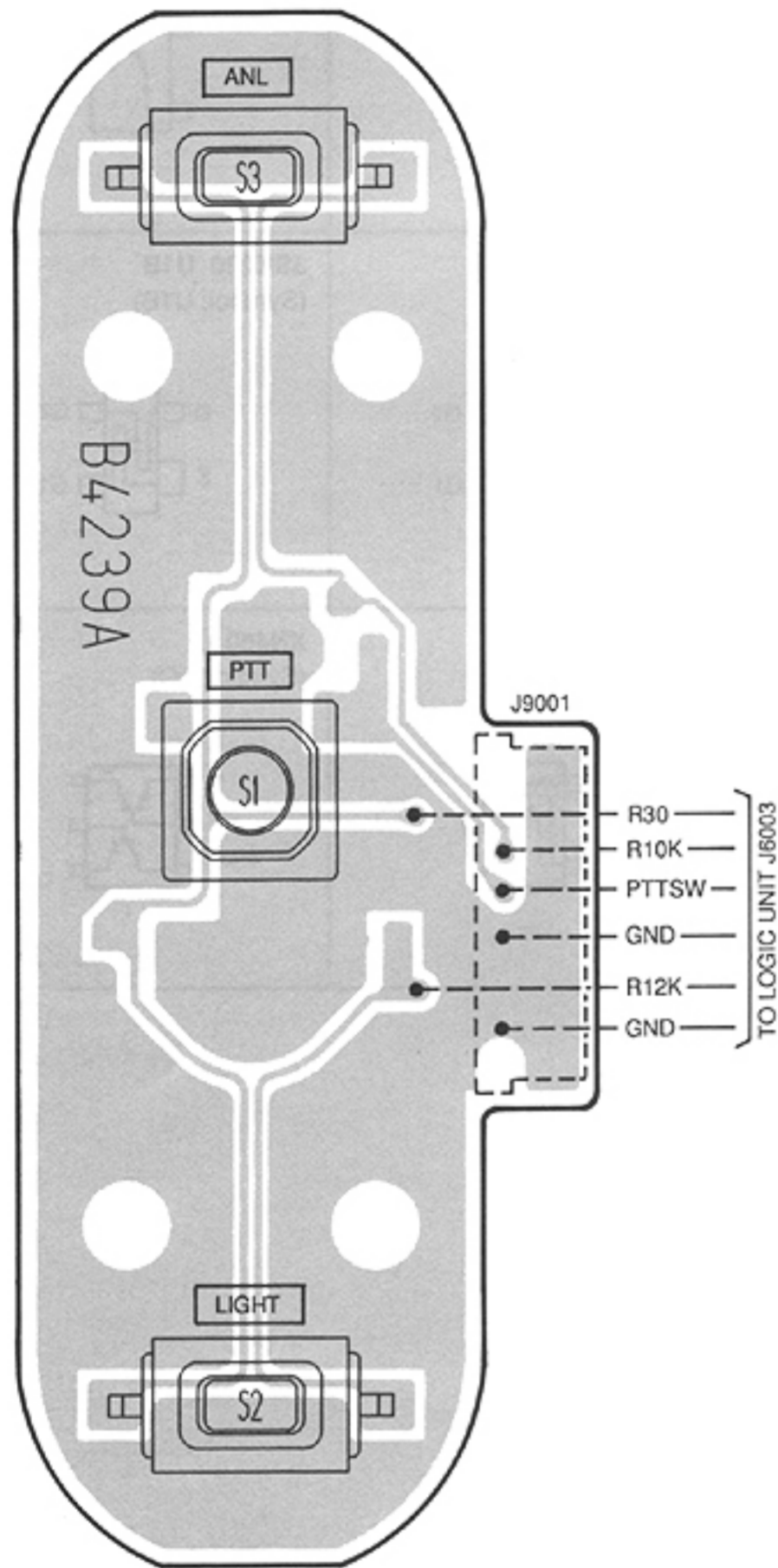

● VCO BOARD

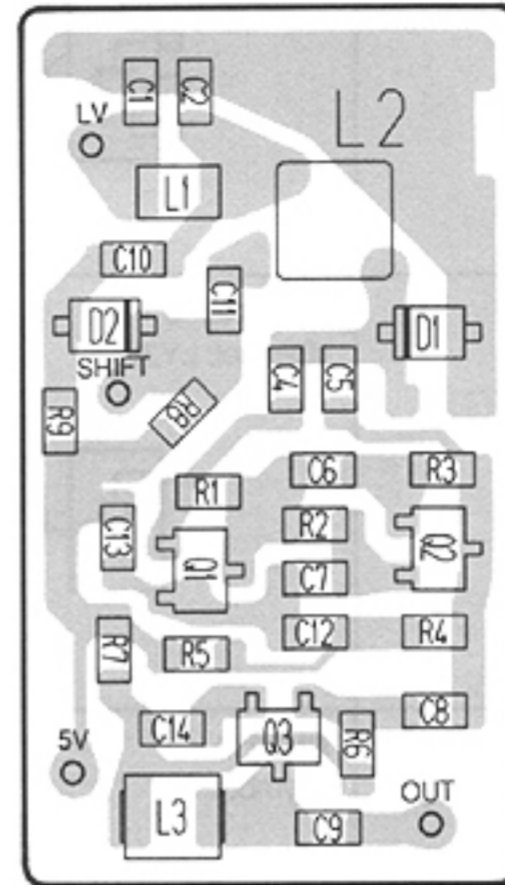

NOTE: Add "7000" to each indicated part number on the board for the actual part number.

NOTE: Add "7000" to each indicated part number on the unit for the actual part number.

● PRT UNIT

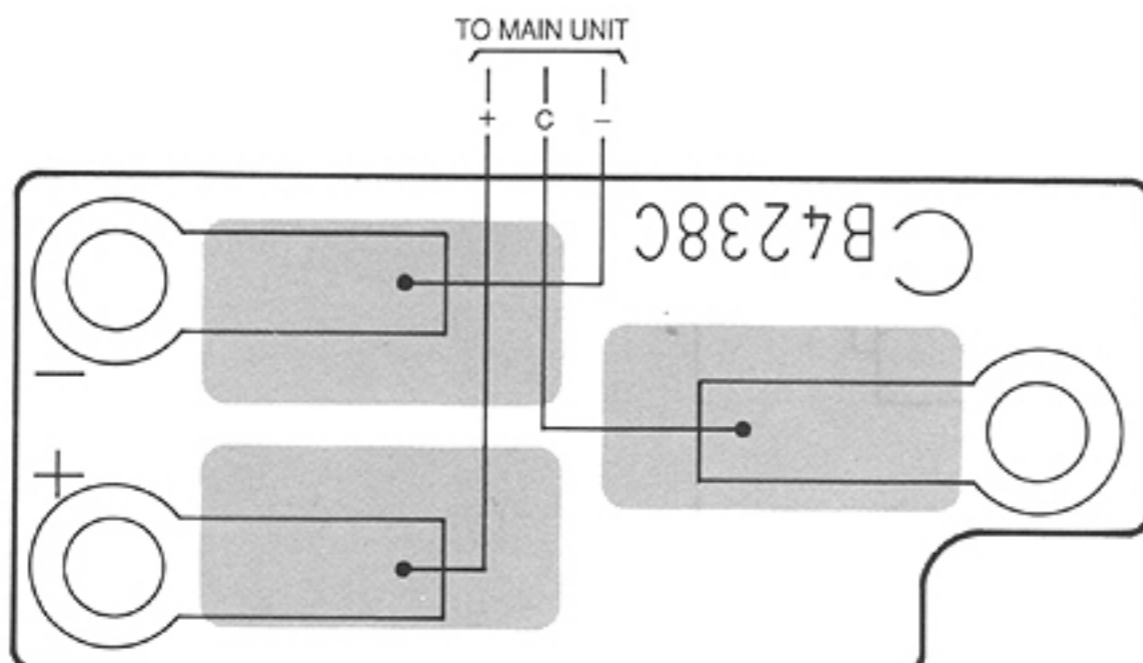

9-2 RF UNIT

The combination of this page and the next page show the until layout in the same configuration as the actual P.C. Board.

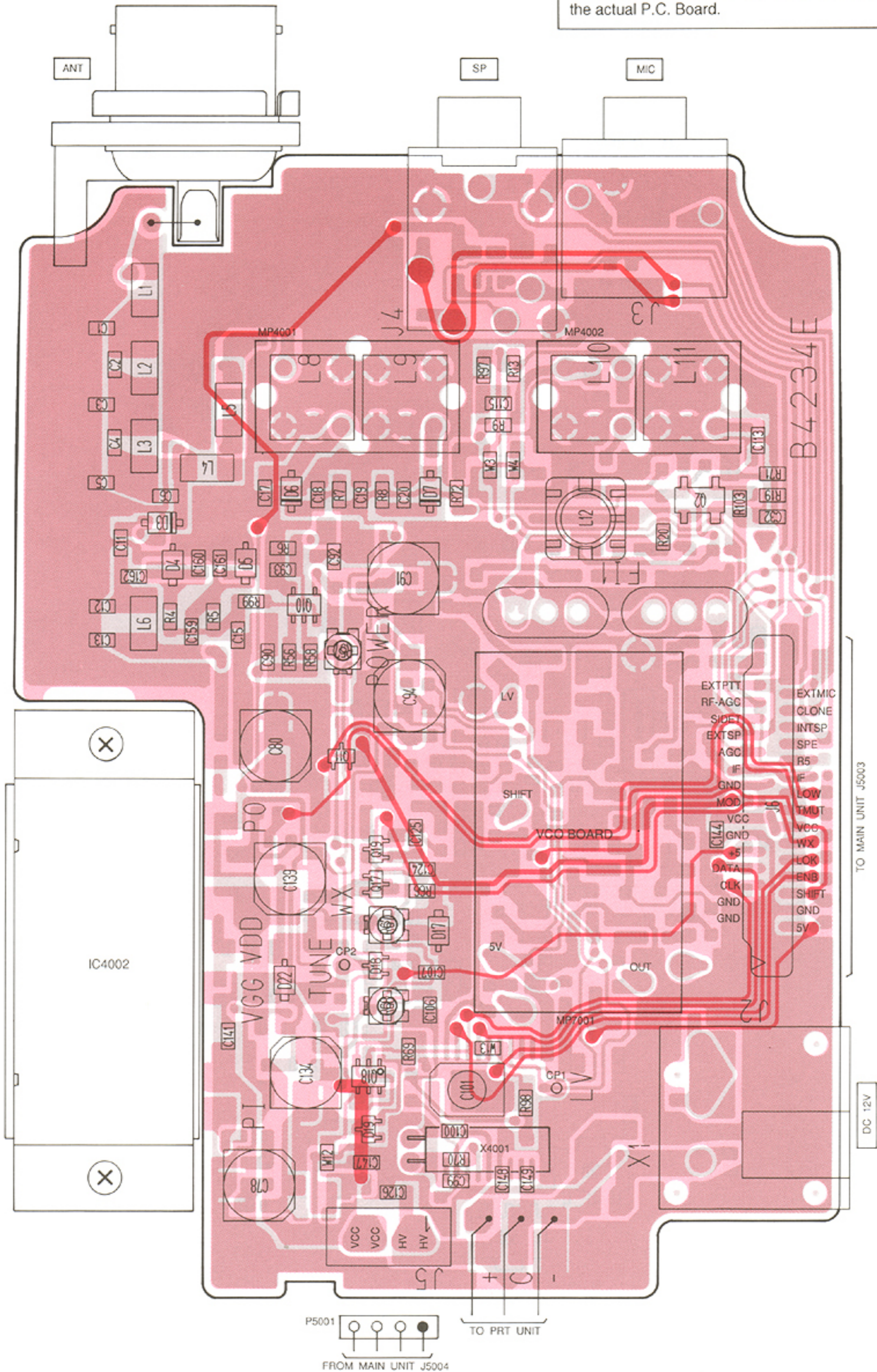

NOTE: Add "4000" to each indicated part number on the unit for the actual part number.

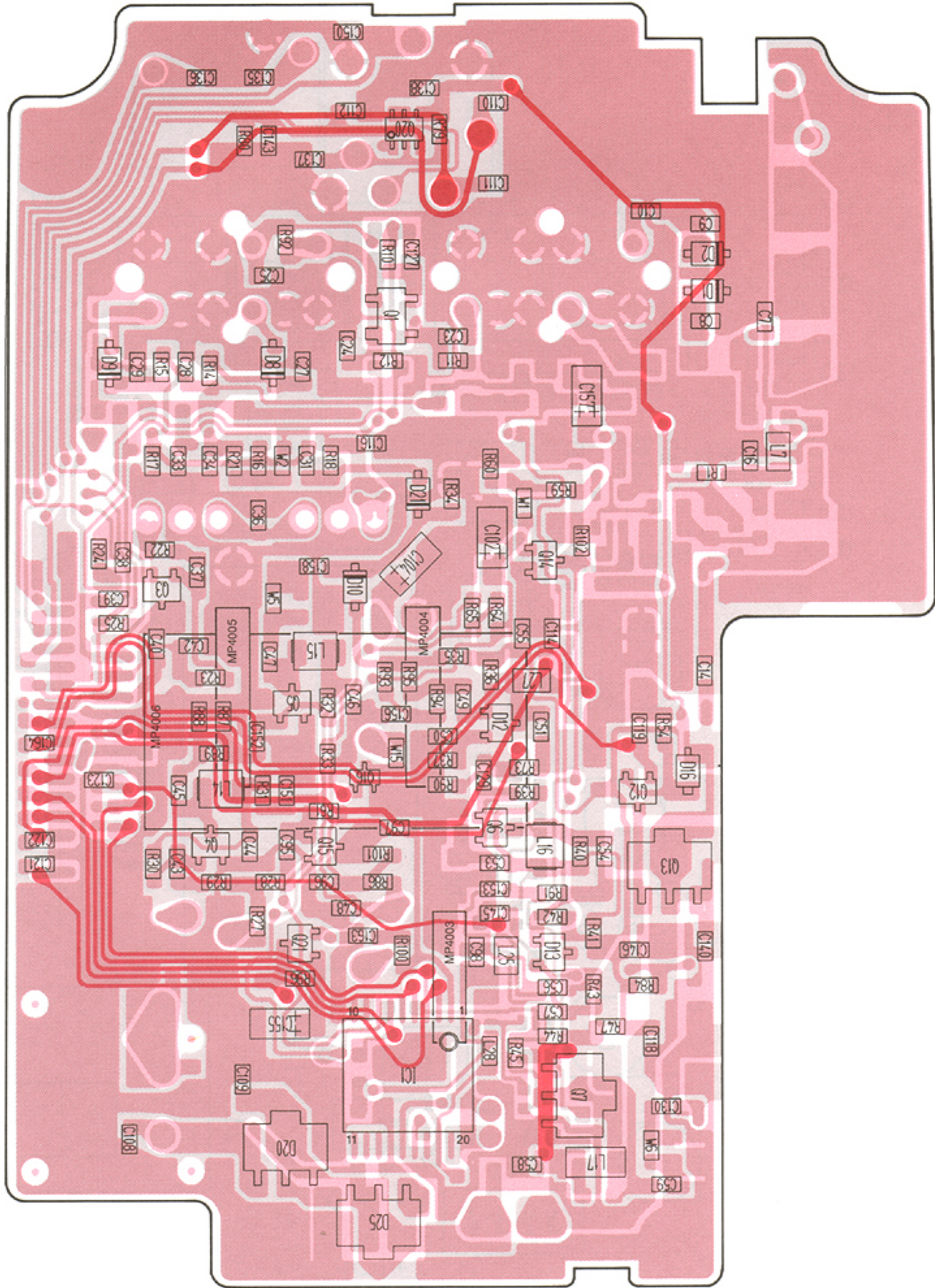

NOTE: Add "4000" to each indicated part number on the unit for the actual part number.

9-3 MAIN UNIT

The combination of this page and the next page show the until layout in the same configuration as the actual P.C. Board.

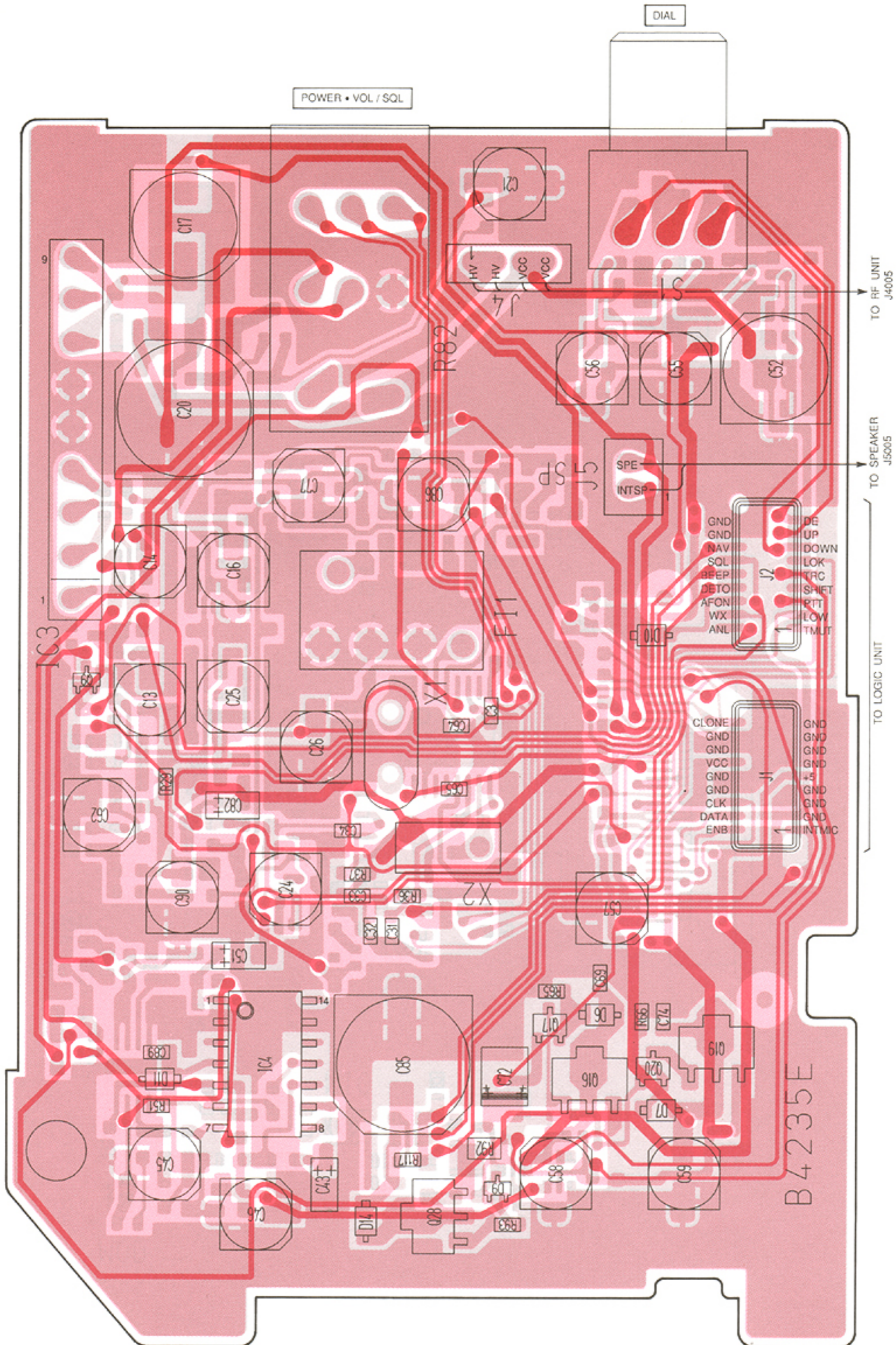

NOTE: Add "5000" to each indicated part number on the unit for the actual part number.

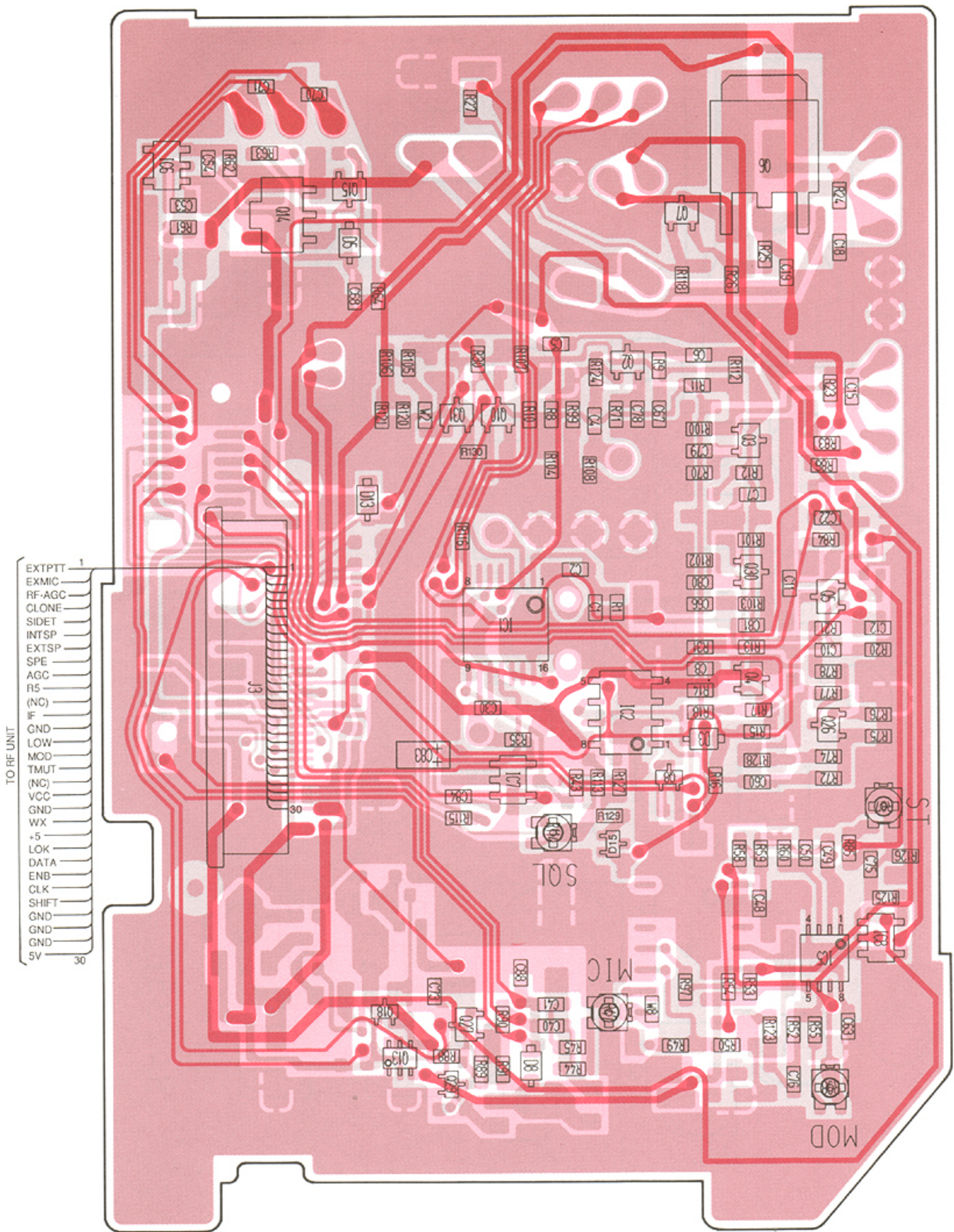

NOTE: Add "5000" to each indicated part number on the unit for the actual part number.

9-4 LOGIC UNIT

• LOGIC UNIT FOR IC-A22/E

The combination of this page and the next page show the until layout in the same configuration as the actual P.C. Board.

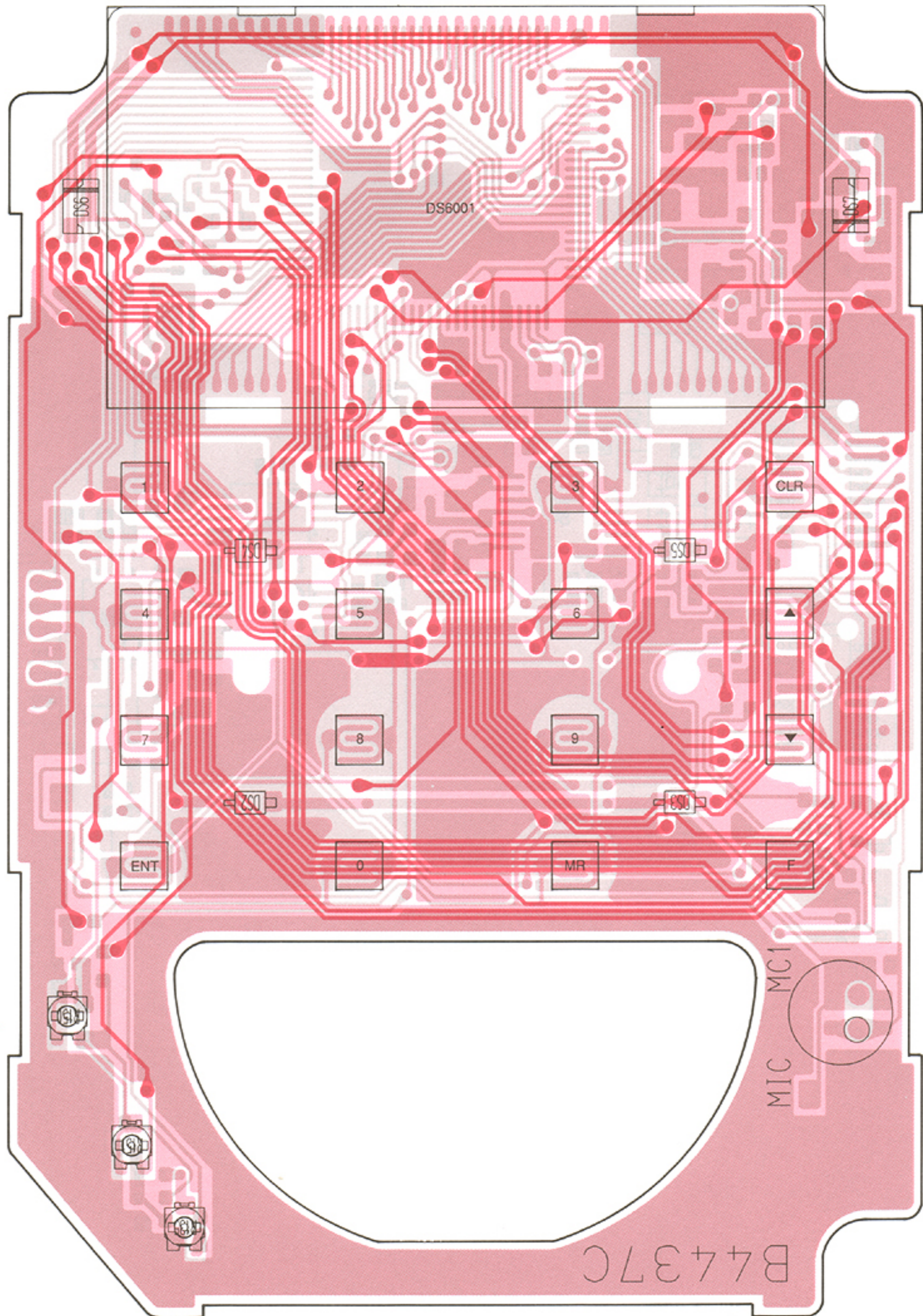

NOTE: Add "6000" to each indicated part number on the unit for the actual part number.

● LOGIC UNIT FOR IC-A22/E

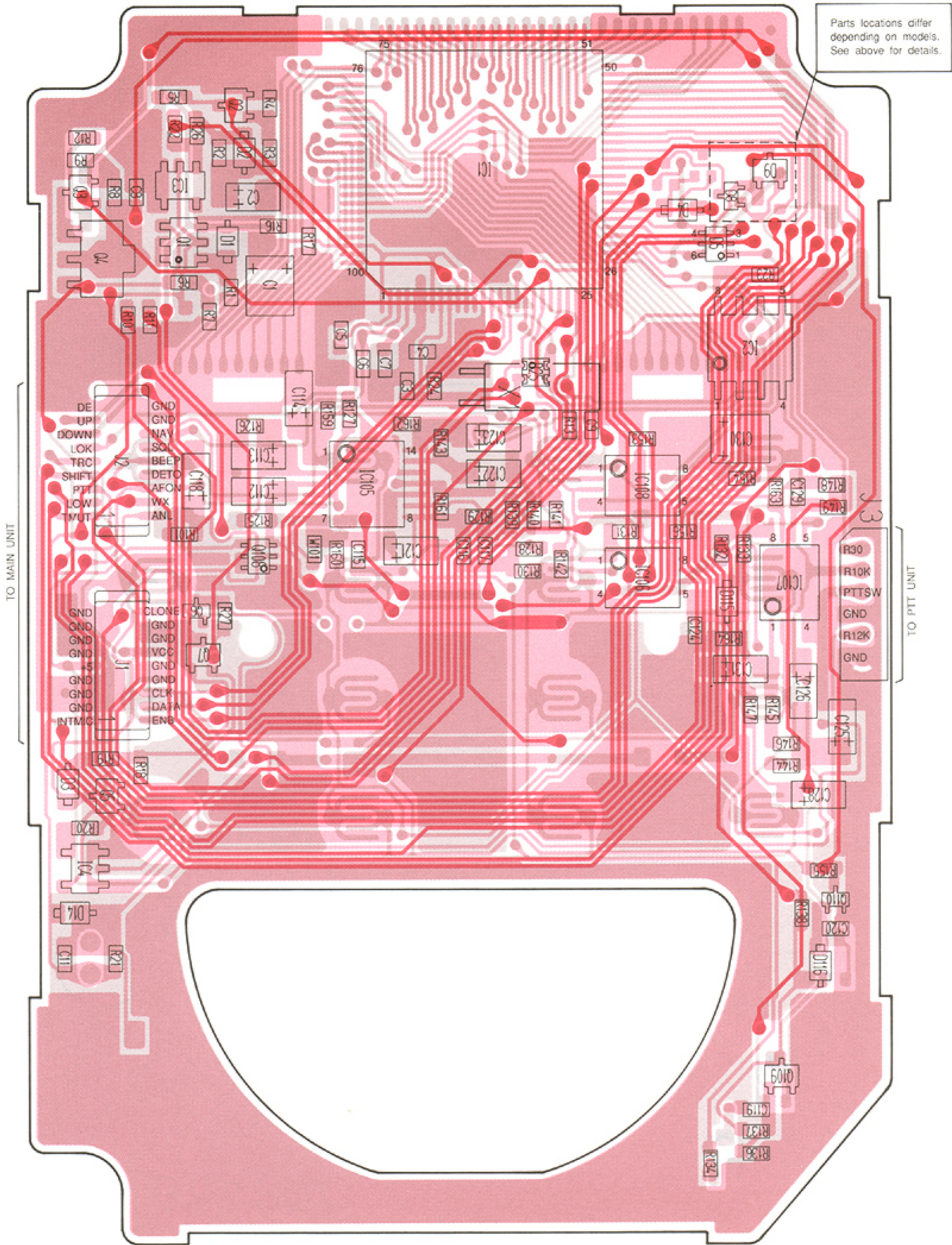
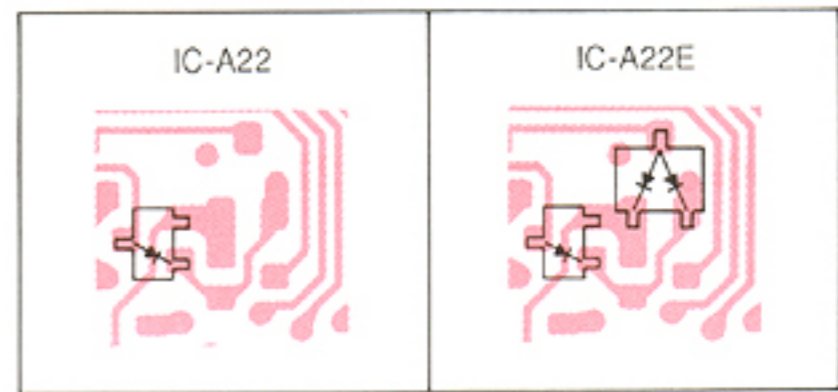

NOTE: Add "6000" to each indicated part number on the unit for the actual part number.

● LOGIC UNIT FOR IC-A3/E

The combination of this page and the next page show the until layout in the same configuration as the actual P.C. Board.

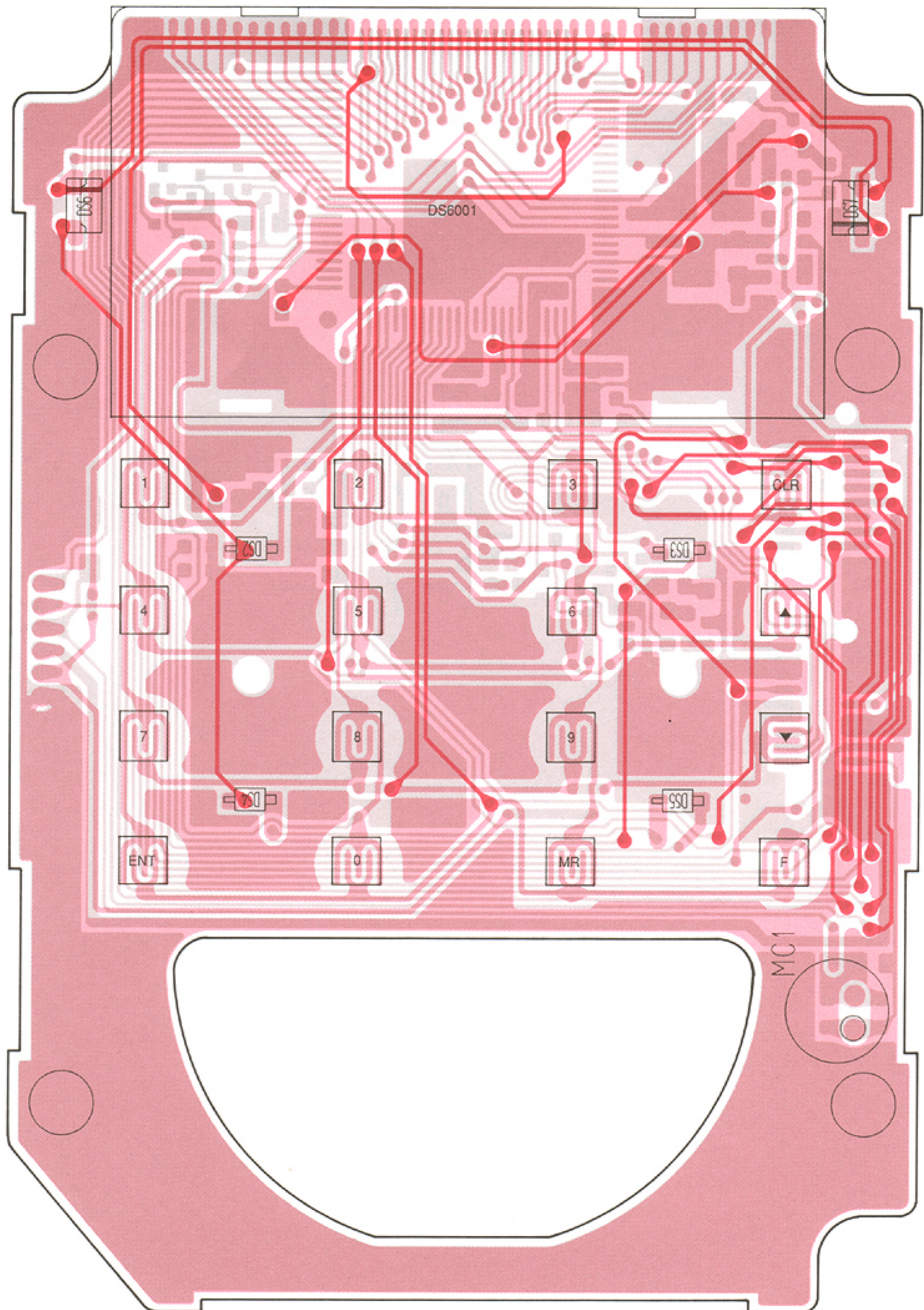

NOTE: Add "6000" to each indicated part number on the unit for the actual part number.

● LOGIC UNIT FOR IC-A3/E

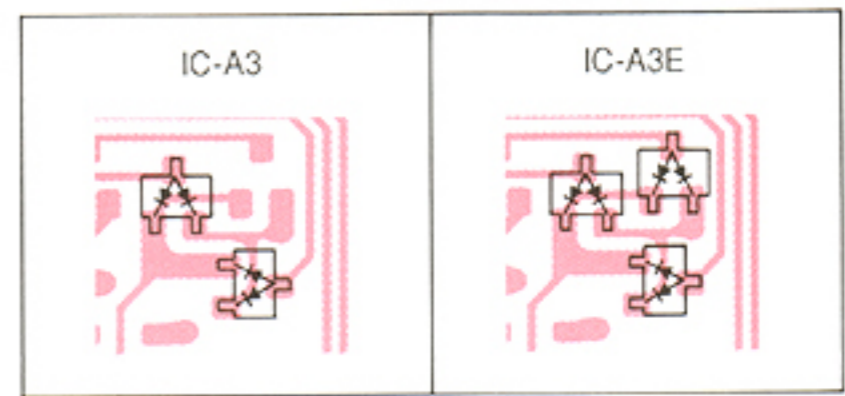

Parts locations differ depending on models. See above for details.

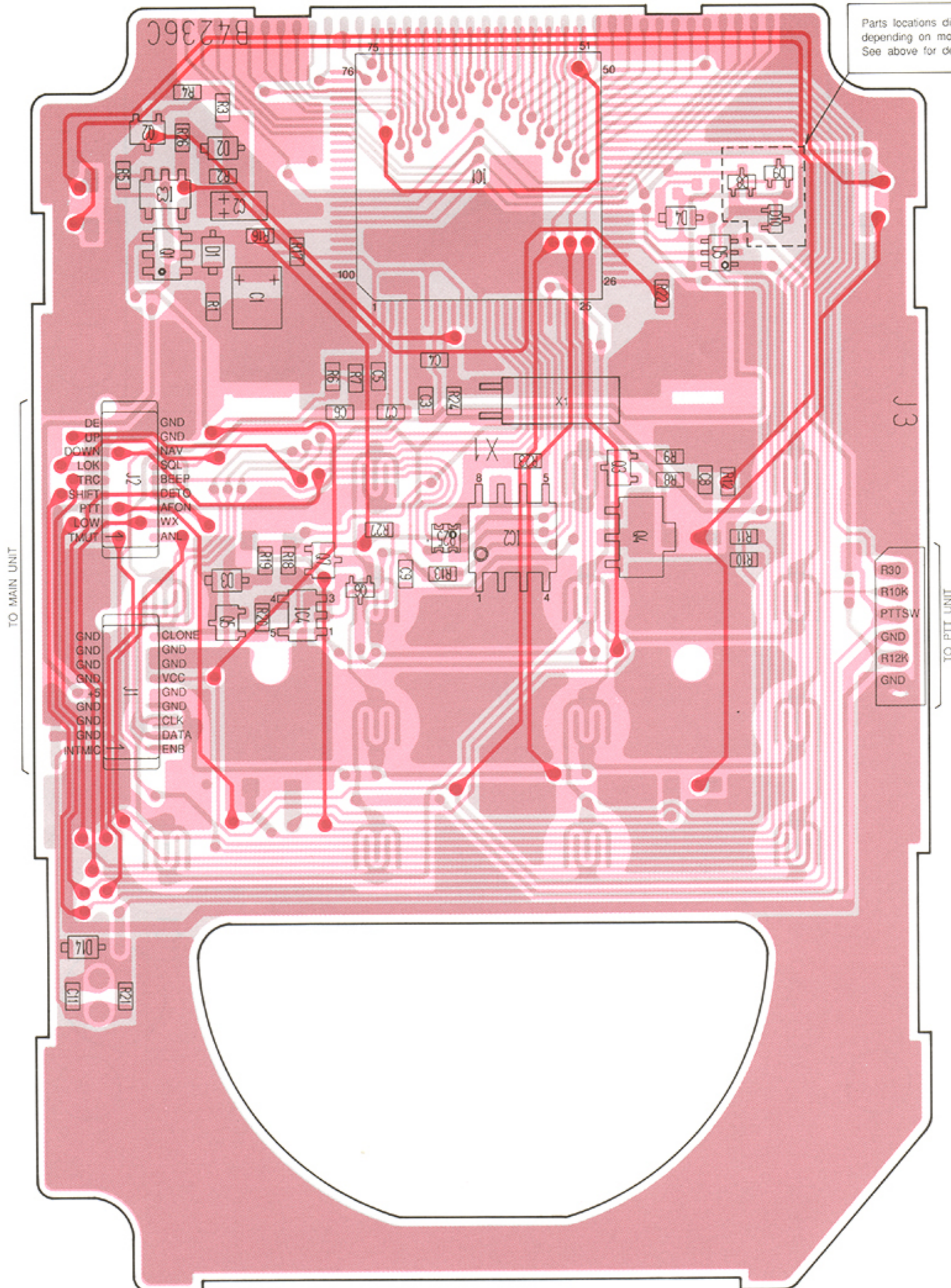

NOTE: Add "6000" to each indicated part number on the unit for the actual part number.

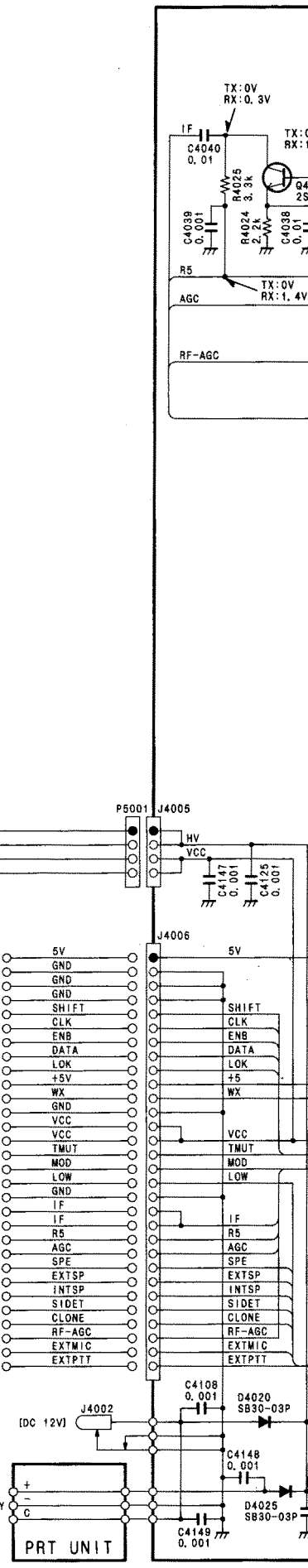
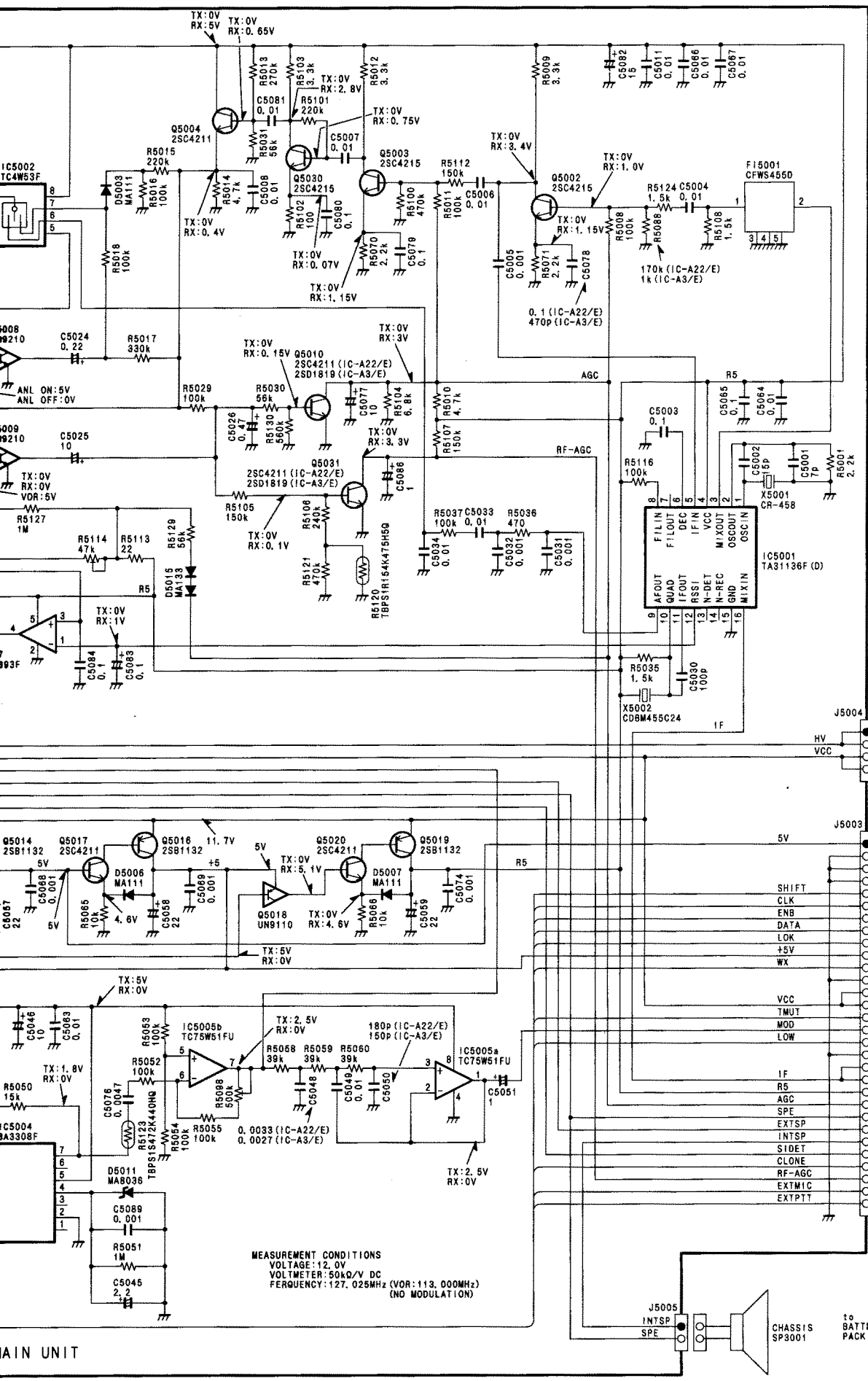

MAIN UNIT

PRT UNIT

MEASUREMENT CONDITIONS
 VOLTAGE: 12.0V
 VOLTMETER: 50kΩ/V DC
 FREQUENCY: 127.025MHz (VOR: 113.000MHz)
 (NO MODULATION)

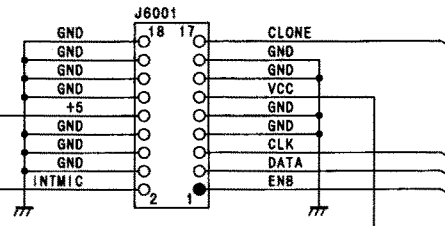
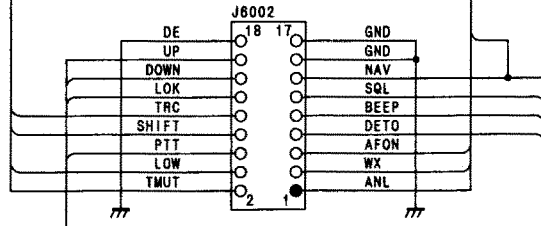
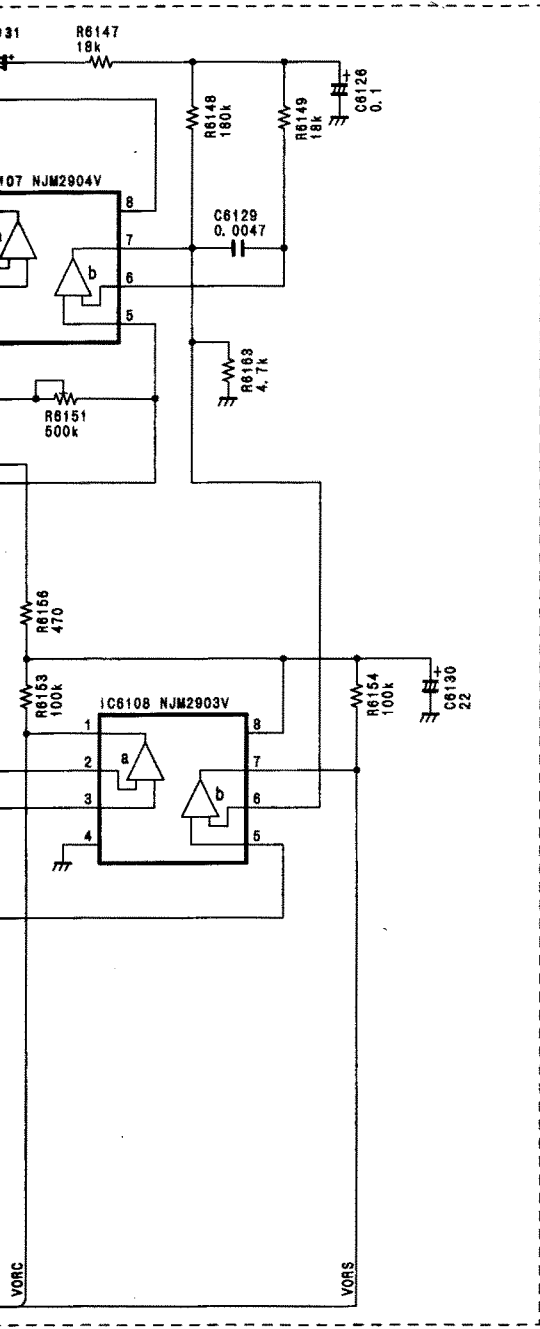
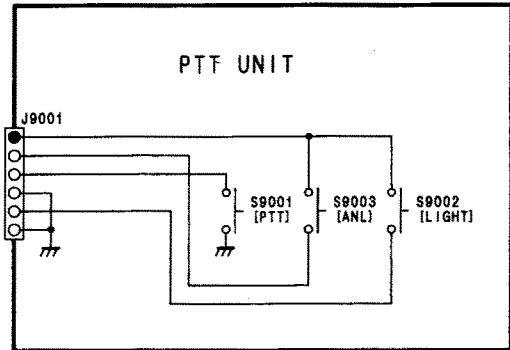
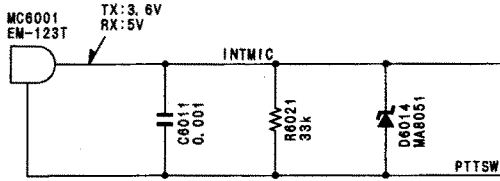

5V

Icom Inc.

1-1-32, Kamiminami, Hirano-ku, Osaka 547-0003, Japan
Phone : 06 6793 5302
Fax : 06 6793 0013
URL : <http://www.icom.co.jp/world/index.html>

Icom America Inc.

<Corporate Headquarters>
2380 116th Avenue N.E., Bellevue, WA 98004, U.S.A.
Phone : (425) 454-8155 Fax : (425) 454-1509
URL : <http://www.icomamerica.com>
<Customer Service>
Phone : (425) 454-7619

Icom Canada

Glenwood Centre #150-6165
Highway 17 Delta, B.C., V4K 5B8, Canada
Phone : (604) 952-4266 Fax : (604) 952-0090
URL : <http://www.icomcanada.com>

Icom (Australia) Pty. Ltd.

A.B.N. 88 006 092 575
290-294 Albert Street, Brunswick, Victoria, 3056, Australia
Phone : 03 9387 0666 Fax : 03 9387 0022
URL : <http://www.icom.net.au>

Icom New Zealand

146A Harris Road, East Tamaki,
Auckland, New Zealand
Phone : 09 274 4062 Fax : 09 274 4708
URL : <http://www.icom.co.nz>

Icom (Europe) GmbH

Communication Equipment
Himmelgeister Str. 100, D-40225 Düsseldorf, Germany
Phone : 0211 346047 Fax : 0211 333639
URL : <http://www.icomeurope.com>

Icom Spain S.L

Ctra. de Gracia a Manresa Km. 14,750
08190 Sant Cugat del Valles Barcelona, SPAIN
Phone : (93) 590 26 70 Fax : (93) 589 04 46
URL : <http://www.icomspain.com>

Icom (UK) Ltd.

Unit 9, Sea St., Herne Bay, Kent, CT6 8LD, U.K.
Phone : 01227 741741 Fax : 01227 741742
URL : <http://www.icomuk.co.uk>

Icom France S.a

Zac de la Plaine, Rue Brindejonc des Moulinais
BP 5804, 31505 Toulouse Cedex, France
Phone : 561 36 03 03 Fax : 561 36 03 00
URL : <http://www.icom-france.com>

Asia Icom Inc.

6F No. 68, Sec. 1 Cheng-Teh Road, Taipei, Taiwan, R.O.C.
Phone : (02) 2559 1899 Fax : (02) 2559 1874

Count on us!

Icom Inc.

1-1-32 Kamiminami, Hirano-ku, Osaka 547-0003 Japan

A-53242H-S-④
Printed in Japan
© 1995 Icom Inc.